

RACE SIGNALS

The meanings of visual and sound signals are stated below. An arrow pointing up or down (↑ ↓) means that a visual signal is displayed or removed. A dot (•) means a sound; five short dashes (-----) mean repetitive sounds; a long dash (—) means a long sound. When a visual signal is displayed over a class flag, the signal applies only to that class.

Postponement Signals

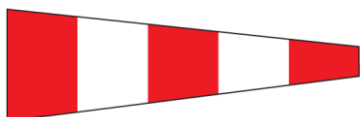

AP Races not started are *postponed*. The warning signal will be made 1 minute after removal unless at that time the race is *postponed* again or *abandoned*.

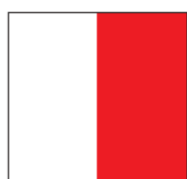
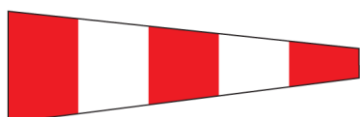

AP over H Races not started are *postponed*. Further signals ashore.

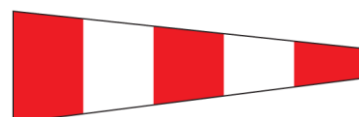

AP over A Races not started are *postponed*. No more racing today.

nt 1-9

Postponement of 1-9 hours from the scheduled starting time.



Pennant 1 ↑•• ↓•



Pennant 2 ↑•• ↓•



Pennant 3 ↑•• ↓•



Pennant 4 ↑•• ↓•



Pennant 5 ↑•• ↓•



Pennant 6 ↑•• ↓•



Pennant 7 ↑•• ↓•



Pennant 8 ↑•• ↓•



Pennant 9 ↑•• ↓•

Abandonment Signals



N All races that have started are *abandoned*. Return to the starting area. The warning signal will be made 1 minute after removal unless at that time the race is *abandoned* again or *postponed*.

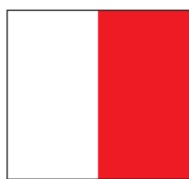

N over H All races are *abandoned*. Further signals ashore.



N over A All races are *abandoned*. No more racing today.

Preparatory Signals



↑● ↓—

P Preparatory signal.

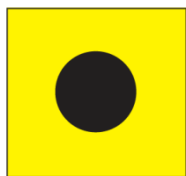

↑● ↓—

I Rule 30.1 is in effect.



↑● ↓—

Z Rule 30.2 is in effect.



↑● ↓—

U Rule 30.3 is in effect.



↑● ↓—

Black flag. Rule 30.4 is in effect.

Recall Signals



↑●

X Individual recall.

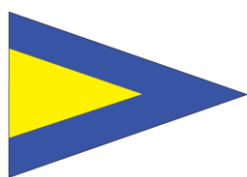

↑●● ↓●

First Substitute General recall. The warning signal will be made 1 minute after removal.

Shortened Course

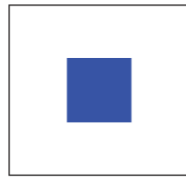

↑●●

S The course has been shortened. Rule 32.2 is in effect.

Changing the Next Leg



C The position of the next *mark* has been changed:

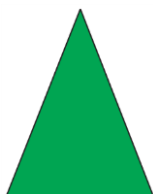

to starboard;



to port;



to decrease the length of the leg;

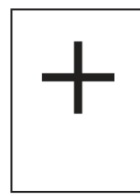

to increase the length of the leg.

Other Signals



↑●

L Ashore: A notice to competitors has been posted. Afloat: Come within hail or follow this vessel.



M The object displaying this signal replaces a missing *mark*.



↑●

Y Wear a personal flotation device (see rule 40).



(no sound)

Blue flag or shape. This race committee vessel is in position at the finishing line.

**THE
RACING RULES
OF
SAILING**

for 2017–2020

**WINDSURFING
COMPETITION RULES**

for 2017–2020

World Sailing

International Windsurfing Association

As the leading authority for the sport, World Sailing promotes and supports the protection of the environment in all sailing competitions and related activities throughout the world.

Contact Details for the World Sailing Executive Office:

Ariadne House
Town Quay
Southampton
Hampshire SO14 2AQ
UK

Tel +44 (0) 2380 635111

Fax +44 (0) 2380 635789

Email office@sailing.org

Website sailing.org

Published by IWA and World Sailing (UK) Limited, Southampton, UK
© World Sailing Limited
October 2017

CONTENTS

	Race Signals	<i>Inside front cover</i>
	Online Rules Documents	4
	Introduction	5
	Definitions	7
	Basic Principles	11
Part 1	Fundamental Rules	12
Part 2	When Boards Meet	14
Part 3	Conduct of a Race	21
Part 4	Other Requirements When Racing	31
Part 5	Protests, Redress, Hearings, Misconduct and Appeals	34
Part 6	Entry and Qualification	47
Part 7	Race Organization	49
	Appendices	
A	Scoring	53
D	Team Racing Rules	58
G	Identification on Sails	65
H	Weighing Clothing and Equipment	69
J	Notice of Race and Sailing Instructions	70
K	Notice of Race Guide	75
L	Sailing Instructions Guide	84
M	Recommendations for Protest Committees	101
N	International Juries	107
R	Procedures for Appeals and Requests	110
S	Standard Sailing Instructions	114
T	Arbitration	120
	Addendum SL Experimental Slalom Rules	122
	Protest Form	135

ONLINE RULES DOCUMENTS

World Sailing has established a single internet address at which readers will find links to all the documents available on the World Sailing website that are mentioned in this book. Those documents are listed below. Links to other rules documents will also be provided at that address.

The address is: sailing.org/racingrules/documents.

Introduction	Guidelines for discretionary penalties	5
	Changes made to these rules after 1 January 2017	6
	World Sailing Codes (Regulations 19, 20, 21, 22, 35, and 37)	6
	<i>Case Book, Call Book for Team Racing</i>	6
Rule G1.1	Up-to-date version of the table of national sail letters	65
Appendix K	Template for Notice of Race Guide	75
Appendix L	Template for Sailing Instructions Guide	84
Appendix LE ,	Expanded Sailing Instructions Guide	84
Appendix M	Guidance on conflicts of interest	101
	Guidance on misconduct	104
Appendix T	International Judges Manual	120

INTRODUCTION

The Windsurfing Competition Rules for 2017-2020 (WCR) has been created as a convenient book for use at windsurfing events. The rules in it are identical to the corresponding rules in *The Racing Rules of Sailing for 2017-2020*. However, each rule in Appendix B in the general rules has been inserted in this book at the appropriate place, followed by its rule number in Appendix B in [brackets]. For example, rule 18.1 in the general rules is shown as rule 18.1 in this book and is followed by '[B2.18.1]'. Like the general rulebook, this book includes two main sections. The first, Parts 1–7, contains rules that affect all windsurfing competitors. The second, Appendices A–T and Addendum SL, provides details of rules, rules that apply to particular kind of sailing, and rules that affect only a small number of competitors or officials.

Terminology

A term used in the sense stated in the Definitions is printed in italics or, in preambles, in bold italics (for example, *racing* and ***racing***).

Each of the terms in the table below is used in *The Racing Rules of Sailing* with the meaning given.

<i>Term</i>	<i>Meaning</i>
Boat	A sailboat, sailboard and the competitor on board.
Sailboard	A board or the competitor.
Competitor	A person who races or intends to race in the event.
National authority	A World Sailing member national authority.
Race committee	The race committee appointed under rule 89.2(c) and any other person or committee performing a race committee function.
Racing rule	A rule in <i>The Racing Rules of Sailing</i> or equivalently in the WCR.
Technical committee	The technical committee appointed under rule 89.2(c) and any other person or committee performing a technical committee function.
Vessel	Any boat or ship.

Other words and terms are used in the sense ordinarily understood in nautical or general use.

Notation The notation ‘[DP]’ in a *rule* means that the penalty for a breach of the *rule* may, at the discretion of the protest committee, be less than disqualification. Guidelines for discretionary penalties are available on the World Sailing website.

Revision The racing rules are revised and published every four years by World Sailing, the international authority for the sport. This edition becomes effective on 1 January 2017 except that for an event beginning in 2016 the date may be postponed by the notice of race and sailing instructions. Marginal markings indicate important changes to Parts 1–7 and the Definitions in the 2013–2016 edition. No changes are contemplated before 2021, but any changes determined to be urgent before then will be announced through national authorities and posted on the World Sailing website.

Appendices When the rules of an appendix apply, they take precedence over any conflicting rules in Parts 1–7 and the Definitions. Each appendix is identified by a letter. A reference to a rule in an appendix will contain the letter and the rule number (for example, ‘rule A1’). The letters I, O and Q are not used to designate appendices in this book. Appendices B, C, E and P are not included in this book.

World Sailing Codes The World Sailing Codes are listed in the table below. The codes are published in the World Sailing Regulations.

<i>Title</i>	<i>Racing Rule</i>	<i>Regulation</i>
Advertising Code	80	20
Anti-Doping Code	5	21
Betting and Anti-Corruption Code	6	37
Disciplinary Code	7	35
Eligibility Code	75.2	19
Sailor Classification Code	79	22

These Codes are referred to in the definition *Rule* but are not included in this book because they can be changed at any time. The most recent versions of the codes are published on the World Sailing website; new versions will be announced through national authorities.

Cases World Sailing publishes interpretations of the racing rules in *The Case Book for 2017–2020* and recognizes them as authoritative interpretations and explanations of the rules. It also publishes *The Book for Team Racing for 2017–2020* and recognizes them as authoritative only for umpired team racing. These publications are available on the World Sailing website.

DEFINITIONS

A term used as stated below is shown in italic type or, in preambles, in bold italic type. The meaning of several other terms is given in Terminology in the Introduction.

Abandon A race that a race committee or protest committee *abandons* is void but may be resailed.

Capsized [B.Definitions] A board is *capsized* when she is not under control because her sail or the competitor is in the water.

Clear Astern and Clear Ahead; Overlap One board is *clear astern* of another when her hull and equipment in normal position are behind a line abeam from the aftermost point of the other board's hull and equipment in normal position. The other board is *clear ahead*. They *overlap* when neither is *clear astern*. However, they also *overlap* when a board between them *overlaps* both. These terms always apply to boards on the same *tack*. They apply to boards on opposite *tacks* only when rule 18 applies between them or when both boards are sailing more than ninety degrees from the true wind.

Conflict of Interest A person has a *conflict of interest* if he/she

- (a) may gain or lose as a result of a decision to which he/she contributes,
- (b) may reasonably appear to have a personal or financial interest which could affect his/her ability to be impartial, or
- (c) has a close personal interest in a decision.

Fetching A board is *fetching a mark* when she is in a position to pass to windward of it and leave it on the required side without changing *tack*.

Finish A board *finishes* when any part of her hull, or crew or equipment in normal position, crosses the finishing line from the course side. However, she has not *finished* if after crossing the finishing line she

- (a) takes a penalty under rule 44.2,
- (b) corrects an error under rule 28.2 made at the line, or
- (c) continues to sail the course.

Keep Clear A board *keeps clear* of a right-of-way board

- (a) if the right-of-way board can sail her course with no need to take avoiding action and,
- (b) when the boards are overlapped, if the right-of-way board can also change course in both directions without immediately making contact.

Leeward and Windward A board's *leeward* side is the side that is or, when she is head to wind, was away from the wind. However, when sailing by the lee or directly downwind, her *leeward* side is the side on which her sail lies. The other side is her *windward* side. When two boards on the same *tack overlap*, the one on the *leeward* side of the other is the *leeward* board. The other is the *windward* board.

Mark An object the sailing instructions require a board to leave on a specified side, and a race committee vessel surrounded by navigable water from which the starting or finishing line extends. An anchor line or an object attached accidentally to a *mark* is not part of it.

Mark-Room [B.Definitions] *Mark-Room* for a board is *room* to sail her *proper course* to round or pass the *mark*. However, *mark-room* for a board does not include *room* to tack unless she is *overlapped* inside and to *windward* of the board required to give *mark-room* and she would be *fetching* the *mark* after her tack.

Obstruction An object that a board could not pass without changing course substantially, if she were sailing directly towards it and one of her hull lengths from it. An object that can be safely passed on only one side and an area so designated by the sailing instructions are also *obstructions*. However, a board *racing* is not an *obstruction* to other boards unless they are required to *keep clear* of her or, if rule 23 applies, avoid her. A vessel under way, including a board *racing*, is never a continuing *obstruction*.

Overlap See *Clear Astern and Clear Ahead; Overlap*.

Party A *party* to a hearing is

- (a) for a protest hearing: a protestor, a protestee;
- (b) for a request for redress: a board requesting redress or for which redress is requested, a race committee acting under rule 60.2(b), a technical committee acting under rule 60.4(b);
- (c) for a request for redress under rule 62.1(a): the body alleged to have made an improper action or omission;
- (d) a person against whom an allegation of a breach of rule 69 is made; a person presenting an allegation under rule 69;
- (e) a *support person* subject to a hearing under rule 60.3(d).

However, the protest committee is never a *party*.

Postpone A *postponed* race is delayed before its scheduled start but may be started or *abandoned* later.

Proper Course A course a board would sail to *finish* as soon as possible in the absence of other boards referred to in the rule using the term. A board has no *proper course* before her starting signal.

Protest An allegation made under rule 61.2 by a board, a race committee, a technical committee or a protest committee that a board has broken a *rule*.

Racing A board is *racing* from her preparatory signal until she *finishes* and clears the finishing line and *marks* or retires, or until the race committee signals a general recall, *postponement* or *abandonment*.

Room The space a board needs in the existing conditions, including space to comply with her obligations under the rules of Part 2 and rule 31, while manoeuvring promptly in a seamanlike way.

Rounding or Passing [B.Definitions] A board is *rounding or passing* a *mark* from the time her *proper course* is to begin to manoeuvre to round or pass it, until the *mark* has been rounded or passed.

Rule

- (a) The rules in this book, including the Definitions, Race Signals, Introduction, preambles and the rules of relevant appendices, but not titles;
- (b) World Sailing Advertising Code, Anti-Doping Code, Betting and Anti-Corruption Code, Disciplinary Code, Eligibility Code, Sailor Classification Code, respectively Regulations 20, 21, 37, 35, 19 and 22;
- (c) the prescriptions of the national authority, unless they are changed by the notice of race or sailing instructions in compliance with the national authority's prescription, if any, to rule 88.2;
- (d) the class rules (for a board racing under a handicap or rating system, the rules of that system are 'class rules');
- (e) the notice of race;
- (f) the sailing instructions; and
- (g) any other documents that govern the event.

Start A board *starts* when, having been entirely on the pre-start side of the starting line at or after her starting signal, and having complied with rule 30.1 if it applies, any part of her hull, competitor or equipment crosses the starting line in the direction of the first *mark*.

Support Person Any person who

- (a) provides, or may provide, physical or advisory support to a competitor, including any coach, trainer, manager, team staff, medic, paramedic or

any other person working with, treating or assisting a competitor in or preparing for the competition, or

(b) is the parent or guardian of a competitor.

Tack, Starboard or Port [B.Definitions] A board is on the *tack*, *starboard* or *port*, corresponding to the competitor's hand that would be nearer the mast if the competitor were in normal sailing position with both hands on the wishbone and arms not crossed. A board is on *starboard tack* when the competitor's right hand would be nearer the mast and is on *port tack* when the competitor's left hand would be nearer the mast.

[B.Definitions] The definition *Zone* is deleted.

The following definitions apply to Expression Competition [B11.Definitions]

Coming In and Going Out A board sailing in the same direction as the incoming surf is *coming in*. A board sailing in the direction opposite to the incoming surf is *going out*.

Jumping A board is *jumping* when she takes off at the top of a wave while *going out*.

Overtaking A board is *overtaking* from the moment she gains an *overlap* from *clear astern* until the moment she is *clear ahead* of the *overtaken* board.

Possession The first board sailing shoreward immediately in front of a wave has *possession* of that wave. However, when it is impossible to determine which board is first the *windward* board has *possession*.

Recovering A board is *recovering* from the time her sail or, when water-starting, the competitor is out of the water until she has steerage way.

Surfing A board is *surfing* when she is on or immediately in front of a wave while *coming in*.

Transition A board changing *tacks*, or taking off while *coming in*, or one that is not *surfing*, *jumping*, *capsized*, or *recovering* is in *transition*.

BASIC PRINCIPLES

SPORTSMANSHIP AND THE RULES

Competitors in the sport of sailing are governed by a body of *rules* that they are expected to follow and enforce. A fundamental principle of sportsmanship is that when competitors break a *rule* they will promptly take a penalty, which may be to retire.

ENVIRONMENTAL RESPONSIBILITY

Participants are encouraged to minimize any adverse environmental impact of the sport of sailing.

WINDSURFING COMPETITION RULES

Windsurfing races shall be sailed under The Racing Rules of Sailing as changed by Appendix B or equivalently under the Windsurfing Competition Rules (WCR). Wherever a rule of Appendix B appears in these Windsurfing Competition Rules, its rule number is stated in brackets. The term 'boat' elsewhere in the racing rules means 'board' or 'boat' as appropriate. The term 'heat' means one elimination race, a 'round' consists of several heats, and an 'elimination series' consists of one or more rounds. However, in speed competition, a 'round' consists of one or more speed 'runs'.

A windsurfing event can include one or more of the following disciplines or their formats:

Discipline	Formats
<i>Racing</i>	<i>Course racing; Slalom; Marathon; Short track; Border cross; Crossing</i>
<i>Expression</i>	<i>Wave performance; Freestyle</i>
<i>Speed</i>	<i>Standard Offshore Speed Course; Speed Crossings; Alpha Speed Course</i>

In racing or expression competition, boards may compete in elimination series, and only a limited number of them may advance from round to round.

A marathon race is a race scheduled to last more than one hour.

In expression competition, a board's performance is judged on skill and variety rather than speed and is organized using elimination series. Either wave performance or freestyle competition is organized, depending on the wave conditions at the venue.

In speed competition, a board's performance is based on her speed over a measured course. Boards take turns sailing runs over the course.

PART 1

FUNDAMENTAL RULES

1 SAFETY

1.1 Helping Those in Danger

A competitor shall give all possible help to any person or vessel in danger.

1.2 Life-Saving Equipment and Personal Flotation Devices

A board shall carry adequate life-saving equipment for all persons on board, including one item ready for immediate use, unless her class rules make some other provision. Each competitor is individually responsible for wearing a personal flotation device adequate for the conditions.

2 FAIR SAILING

A board and her owner shall compete in compliance with recognized principles of sportsmanship and fair play. A board may be penalized under this rule only if it is clearly established that these principles have been violated. The penalty shall be either disqualification or disqualification that is not excludable.

3 ACCEPTANCE OF THE RULES

3.1 (a) By participating or intending to participate in a race conducted under these *rules*, each competitor and board owner agrees to accept these *rules*.

(b) A *support person* by providing support, or a parent or guardian by permitting their child to enter a race, agrees to accept the *rules*.

3.2 Each competitor and board owner agrees, on behalf of their *support persons*, that such *support persons* are bound by the *rules*.

3.3 Acceptance of the *rules* includes agreement

(a) to be governed by the *rules*;

(b) to accept the penalties imposed and other action taken under the *rules*, subject to the appeal and review procedures provided in them, as the final determination of any matter arising under the *rules*;

(c) with respect to any such determination, not to resort to any court of law or tribunal not provided for in the *rules*; and

(d) by each competitor and board owner to ensure that their *support persons* are aware of the *rules*.

3.4 The person in charge of each board shall ensure that the competitor and the board's owner are aware of their responsibilities under this rule.

3.5 This rule may be changed by a prescription of the national authority of the venue.

4 DECISION TO RACE

The responsibility for a board's decision to participate in a race or to continue *racing* is hers alone.

5 ANTI-DOPING

A competitor shall comply with the World Anti-Doping Code, the rules of the World Anti-Doping Agency, and World Sailing Regulation 21, Anti-Doping Code. An alleged or actual breach of this rule shall be dealt with under Regulation 21. It shall not be grounds for a *protest* and rule 63.1 does not apply.

6 BETTING AND ANTI-CORRUPTION

Each competitor, board owner and *support person* shall comply with World Sailing Regulation 37, Betting and Anti-Corruption Code. An alleged or actual breach of this rule shall be dealt with under Regulation 37. It shall not be grounds for a *protest* and rule 63.1 does not apply.

7 DISCIPLINARY CODE

Each competitor, board owner and *support person* shall comply with World Sailing Regulation 35, Disciplinary, Appeals and Review Code (referred to as 'Disciplinary Code' elsewhere). An alleged or actual breach of this rule shall be dealt with under Regulation 35. It shall not be grounds for a *protest* and rule 63.1 does not apply.

PART 2

WHEN BOARDS MEET

*The rules of Part 2 apply between boards that are sailing in or near the racing area and intend to **race**, are **racing**, or have been **racing**. However, a board not **racing** shall not be penalized for breaking one of these rules, except rule 14 when the incident resulted in injury or serious damage, or rule 24.1.*

When a board sailing under these rules meets a vessel that is not, she shall comply with the International Regulations for Preventing Collisions at Sea (IRPCAS) or government right-of-way rules. If the sailing instructions so state, the rules of Part 2 are replaced by the right-of-way rules of the IRPCAS or by government right-of-way rules.

SECTION A

RIGHT OF WAY

*A board has right of way over another board when the other board is required to **keep clear** of her. However, some rules in Sections B, C and D limit the actions of a right-of-way board.*

10 ON OPPOSITE TACKS

*When boards are on opposite *tacks*, a *port-tack* board shall *keep clear* of a *starboard-tack* board.*

11 ON THE SAME TACK, OVERLAPPED

*When boards are on the same *tack* and *overlapped*, a *windward* board shall *keep clear* of a *leeward* board.*

12 ON THE SAME TACK, NOT OVERLAPPED

*When boards are on the same *tack* and not *overlapped*, a board *clear astern* shall *keep clear* of a board *clear ahead*.*

13 [B2.13] WHILE TACKING

*After a board passes head to wind, she shall keep clear of other boards until her sail has filled. During that time rules 10, 11 and 12 do not apply. If two boards are subject to this rule at the same time, the one on the other's port side or the one astern shall *keep clear*.*

SECTION B GENERAL LIMITATIONS

14 AVOIDING CONTACT

A board shall avoid contact with another board if reasonably possible. However, a right-of-way board or one entitled to *room* or *mark-room*

- (a) need not act to avoid contact until it is clear that the other board is not *keeping clear* or giving *room* or *mark-room*, and
- (b) shall be exonerated if she breaks this rule and the contact does not cause damage or injury.

15 ACQUIRING RIGHT OF WAY

When a board acquires right of way, she shall initially give the other board *room to keep clear*, unless she acquires right of way because of the other board's actions.

16 CHANGING COURSE

16.1 When a right-of-way board changes course, she shall give the other board *room to keep clear*.

16.2 In addition, when after the starting signal a *port-tack* board is *keeping clear* by sailing to pass astern of a *starboard-tack* board, the *starboard-tack* board shall not change course if as a result the *port-tack* board would immediately need to change course to continue *keeping clear*.

17 [B2.17] ON THE SAME TACK BEFORE A REACHING START

When, at the warning signal, the course to the first *mark* is approximately ninety degrees from the true wind, a board *overlapped* to *leeward* of another board on the same *tack* during the last 30 seconds before her starting signal shall not sail above the shortest course to the first mark while they remain *overlapped* if as a result the other board would need to take action to avoid contact, unless in doing so she promptly sails astern of the other board.

SECTION C AT MARKS AND OBSTRUCTIONS

Section C rules do not apply at a starting mark surrounded by navigable water or at its anchor line from the time boards are approaching them to start until they have passed them.

18 [B2.18] MARK-ROOM**18.1 When Rule 18 Applies**

Rule B2.18 applies between boards when they are required to leave a *mark* on the same side and at least one of them is *rounding or passing* it. However, it does not apply

- (a) between boards on opposite *tacks* on a beat to windward,
- (b) between boards on opposite *tacks* when the *proper course* at the *mark* for one but not both of them is to tack,
- (c) between a board approaching a *mark* and one leaving it, or
- (d) if the *mark* is a continuing *obstruction*, in which case rule 19 applies.

18.2 Giving Mark-Room

- (a) When boards are *overlapped*, the outside board shall give the inside board *mark-room*, unless rule 18.2(b) applies.
- (b) If boards are *overlapped* when the first of them is *rounding or passing*, the outside board at that moment shall thereafter give the inside board *mark-room*. If a board is *clear ahead* when she is *rounding or passing*, the board *clear astern* at that moment shall thereafter give her *mark-room*.
- (c) When a board is required to give *mark-room* by rule B2.18.2(b), she shall continue to do so even if later an *overlap* is broken or a new *overlap* begins.
- (d) Rules B2.18.2(b) and (c) cease to apply when the board entitled to *mark-room* has been given that *mark-room*, or if she passes head to wind.
- (e) If there is reasonable doubt that a board obtained or broke an *overlap* in time, it shall be presumed that she did not.
- (f) If a board obtained an inside *overlap* from *clear astern* or by tacking to *windward* of the other board and, from the time the *overlap* began, the outside board has been unable to give *mark-room*, she is not required to give it.

18.3 Rule 18.3 is deleted.

18.4 [B2.18.4] Gybing or Bearing Away

When an inside *overlapped* right-of-way board must gybe or bear away at a *mark* to sail her *proper course*, until she gybes or bears away she shall sail no farther from the *mark* than needed to sail that course. Rule B2.18.4 does not apply at a gate *mark*.

19 ROOM TO PASS AN OBSTRUCTION

19.1 When Rule 19 Applies

Rule 19 applies between two boards at an *obstruction* except

- (a) when the *obstruction* is a *mark*, the boards are required to leave on the same side, or
- (b) when rule 18 applies between the boards and the *obstruction* is another board *overlapped* with each of them.

However, at a continuing *obstruction*, rule 19 always applies and rule 18 does not.

19.2 Giving Room at an Obstruction

- (a) A right-of-way board may choose to pass an *obstruction* on either side.
- (b) When boards are *overlapped*, the outside board shall give the inside board *room* between her and the *obstruction*, unless she has been unable to do so from the time the *overlap* began.
- (c) While boards are passing a continuing *obstruction*, if a board that was *clear astern* and required to *keep clear* becomes *overlapped* between the other board and the *obstruction* and, at the moment the *overlap* begins, there is not *room* for her to pass between them, she is not entitled to *room* under rule 19.2(b). While the boards remain *overlapped*, she shall *keep clear* and rules 10 and 11 do not apply.

20 ROOM TO TACK AT AN OBSTRUCTION

20.1 Hailing

A board may hail for *room* to tack and avoid a board on the same *tack*. However, she shall not hail unless

- (a) she is approaching an *obstruction* and will soon need to make a substantial course change to avoid it safely, and
- (b) she is sailing close-hauled or above.

In addition, she shall not hail if the *obstruction* is a *mark* and a board that is *fetching* it would be required to change course as a result of the hail.

20.2 Responding

- (a) After a board hails, she shall give a hailed board time to respond.
- (b) A hailed board shall respond even if the hail breaks rule 20.1.

- (c) A hailed board shall respond either by tacking as soon as possible, or by immediately replying ‘You tack’ and then giving the hailing board *room* to tack and avoid her.
- (d) When a hailed board responds, the hailing board shall tack as soon as possible.
- (e) From the time a board hails until she has tacked and avoided a hailed board, rule 18.2 does not apply between them.

20.3 Passing On a Hail to an Additional Board

When a board has been hailed for *room* to tack and she intends to respond by tacking, she may hail another board on the same *tack* for *room* to tack and avoid her. She may hail even if her hail does not meet the conditions of rule 20.1. Rule 20.2 applies between her and a board she hails.

SECTION D OTHER RULES

When rule 22 or 23 applies between two boards, Section A rules do not.

21 EXONERATION

When a board is sailing within the *room* or *mark-room* to which she is entitled, she shall be exonerated if, in an incident with a board required to give her that *room* or *mark-room*, she breaks a rule of Section A, rule 15 or rule 16.

22 STARTING ERRORS; TAKING PENALTIES; BACKING A SAIL

22.1 A board sailing towards the pre-start side of the starting line or one of its extensions after her starting signal to *start* or to comply with rule 30.1 shall *keep clear* of a board not doing so until she is completely on the pre-start side.

22.2 A board taking a penalty shall *keep clear* of one that is not.

22.3 A board moving astern, or sideways to windward, through the water by backing a sail shall *keep clear* of one that is not.

23 [B2.23] CAPSIZED, AGROUND; RESCUING

23.1 [B2.23.1] If possible, a board shall avoid a board that is *capsized* or has not regained control after *capsizing*, is aground, or is trying to help a person or vessel in danger.

23.2 [B2.23.2] If possible, a board that is *capsized* or aground shall not interfere with another board.

**24 [B2.24] INTERFERING WITH ANOTHER BOARD;
SAIL OUT OF WATER**

24.1 If reasonably possible, a board not *racing* shall not interfere with a board that is *racing*.

24.2 If reasonably possible, a board shall not interfere with a board that is taking a penalty, sailing on another leg or subject to rule 22.1. However, after the starting signal this rule does not apply when the board is sailing her *proper course*.

24.3 [B2.24.3] In the last minute before her starting signal, a board shall have her sail out of the water and in a normal position, except when accidentally *capsized*.

SECTION E

RULES FOR OTHER DISCIPLINES

RULES FOR EXPRESSION AND SPEED COMPETITIONS

The rules of Part 2 are deleted and replace by:

E1 [B11 Part2] Right-of-way Rules for Expression Competition

(a) COMING IN AND GOING OUT

A board *coming in* shall *keep clear* of a board *going out*. When two boards are *going out* or *coming in* while on the same wave, or when neither is *going out* or *coming in*, a board on *port tack* shall *keep clear* of the one on *starboard tack*.

(b) BOARDS ON THE SAME WAVE, COMING IN

When two or more boards are on a wave *coming in*, a board that does not have *possession* shall *keep clear*.

(c) CLEAR ASTERN, CLEAR AHEAD AND OVERTAKING

A board *clear astern* and not on a wave shall *keep clear* of a board *clear ahead*. An *overtaking* board that is not on a wave shall *keep clear*.

(d) TRANSITION

A board in *transition* shall *keep clear* of one that is not. When two boards are in *transition* at the same time, the one on the other's port side or the one astern shall *keep clear*.

(e) JUMPING

A board that is *jumping* shall *keep clear* of one that is not.

E2 [B12 Part 2(a),(b),(d)] Rules for Speed Competition

(a) WATER STARTING

A board shall not water start on the course or in the starting area, except to sail off the course to avoid boards that are making, or about to make, a run.

(b) LEAVING THE COURSE AREA

A board leaving the course area shall *keep clear* of boards making a run.

(c) RETURNING TO THE STARTING AREA

A board returning to the starting area shall keep clear of the course.

PART 3

CONDUCT OF A RACE

25 NOTICE OF RACE, SAILING INSTRUCTIONS AND SIGNALS

25.1 The notice of race and sailing instructions shall be made available to each board before a race begins.

25.2 The meanings of the visual and sound signals stated in Race Signals shall not be changed except under rule 86.1(b). The meanings of any other signals that may be used shall be stated in the notice of race or sailing instructions.

25.3 When the race committee is required to display a flag as a visual signal, it may use a flag or other object of a similar appearance.

26 STARTING RACES

26. [B3.26.1] System 1

Races shall be started by using the following signals. Times shall be taken from the visual signals; the absence of a sound signal shall be disregarded.

<i>Minutes before starting signal</i>	<i>Visual signal</i>	<i>Sound signal</i>	<i>Means</i>
5*	Class flag	One	Warning signal
4	P, I, Z, Z with I, U, or black flag	One	Preparatory signal
1	Preparatory flag removed	One long	One minute
0	Class flag removed	One	Starting signal

*or as stated in the sailing instructions

The warning signal for each succeeding class shall be made with or after the starting signal of the preceding class.

26.2 [B3.26.2] System 2

Races shall be started by using the following signals. Times shall be taken from the visual signals; the absence of a sound signal shall be disregarded.

<i>Minutes before starting signal</i>	<i>Visual signal</i>	<i>Sound signal</i>	<i>Means</i>
3	Class flag or heat number		Attention signal
2	Red flag; attention signal removed	One	Warning signal
1	Yellow flag; red flag removed	One	Preparatory signal
1/2	Yellow flag removed		30 seconds
0	Green flag	One	Starting signal

26.3 [B3.26.3] System 3 (for Beach Starts)

- (a) When the starting line is on the beach, or so close to the beach that the competitor must stand in the water to *start*, the start is a beach start.
- (b) The starting stations shall be numbered so that station 1 is the most windward one. Unless the sailing instructions specify some other system, a board's starting station shall be determined
 - (1) for the first race or round of the event, by draw, or
 - (2) for any race or round after the first one, by her place in the previous race or heat (The first place on station 1, the second place on station 2, and so on.).
- (c) After boards have been called to take their positions, the race committee shall make the preparatory signal by displaying a red flag with one sound. The starting signal shall be made, at any time after the preparatory signal, by removing the red flag with one sound.
- (d) After the starting signal each board shall take the shortest route from her starting station to the water and then to her sailing position without interfering with other boards. Part 2 rules will apply when both of the competitor's feet are on the board.

26.4 [B11.26] System 4 (for Expression Competition)**STARTING AND ENDING HEATS**

Heats shall be started and ended by using the following signals:

(a) STARTING A HEAT

Each flag shall be removed when the next flag is displayed.

<i>Minutes before starting signal</i>	<i>Visual signal</i>	<i>Sound signal</i>	<i>Means</i>
Beginning of transition period	Heat number with red flag	One	Warning
1	Yellow flag	One	Preparatory
0	Green flag	One	Starting signal

(b) ENDING A HEAT

<i>Minutes before ending signal</i>	<i>Visual signal</i>	<i>Sound signal</i>	<i>Means</i>
1	Green flag removed	One	End warning
0	Red flag	One	Ending signal

26.5 [B12.26] System 5 (for Speed Competition)

Rounds shall be started and ended by using the following signals. Each flag shall be removed when the next flag is displayed.

(a) STARTING A ROUND

<i>Signal</i>	<i>Flag</i>	<i>Means</i>
Stand-by	AP flag	Course closed. Races are postponed
Course closed	Red flag	Course closed; will open shortly
Preparatory	Red and yellow flag	Course will open in 5 minutes
Starting	Green flag	Course is open

(b) ENDING A ROUND

<i>Signal</i>	<i>Flag</i>	<i>Means</i>
End warning	Green and yellow flag	Course will be closed in 5 minutes
Extension	Yellow flag	Current round extended by 15 minutes
Round ended	Red flag	A new round will be started shortly

27 OTHER RACE COMMITTEE ACTIONS BEFORE THE STARTING SIGNAL

- 27.1** No later than the warning signal, the race committee shall signal or otherwise designate the course to be sailed if the sailing instructions have not stated the course, and it may replace one course signal with another and signal that wearing personal flotation devices is required (display flag Y with one sound).
- 27.2** No later than the preparatory signal, the race committee may move a starting *mark*.
- 27.3** Before the starting signal, the race committee may for any reason *postpone* (display flag AP, AP over H, or AP over A, with two sounds) or *abandon* the race (display flag N over H, or N over A, with three sounds).

28 SAILING THE COURSE

- 28.1** A board shall *start*, sail the course described in the sailing instructions and *finish*. While doing so, she may leave on either side a *mark* that does not begin, bound or end the leg she is sailing. After *finishing* she need not cross the finishing line completely.
- 28.2** A string representing a board's track from the time she begins to approach the starting line from its pre-start side to *start* until she *finishes* shall, when drawn taut,
- pass each *mark* on the required side and in the correct order,
 - touch each rounding *mark*, and
 - pass between the *marks* of a gate from the direction of the previous *mark*.

She may correct any errors to comply with this rule, provided she has not *finished*.

29 RECALLS

29.1 Individual Recall

When at a board's starting signal any part of her hull, crew or equipment is on the course side of the starting line or she must comply with rule 30.1, the race committee shall promptly display flag X with one sound. The flag shall be displayed until all such boards have sailed completely to the pre-start side of the starting line or one of its extensions and have complied with rule 30.1, if it applies, but no later than four minutes after the starting signal or one minute before any later starting signal, whichever is earlier. If rule 30.3 or 30.4 applies, this rule does not.

29.2 General Recall

When at the starting signal the race committee is unable to identify boards that are on the course side of the starting line or to which rule 30 applies, or there has been an error in the starting procedure, the race committee may signal a general recall (display the First Substitute with two sounds). The warning signal for a new start for the recalled class shall be made one minute after the First Substitute is removed (one sound), and the starts for any succeeding classes shall follow the new start.

29.3 [B10.29] RECALLS IN ELIMINATION SERIES

For a race of an elimination series that will qualify a board to compete in a later stage of an event, rule 29 is changed to:

- (a) When at a board's starting signal any part of her hull, crew or equipment is on the course side of the starting line, the race committee shall signal a general recall.
- (b) If the race committee acts under rule B10.29(a) and the board is identified, she shall be disqualified without a hearing, even if the race is *abandoned*. The race committee shall hail or display her sail number, and she shall leave the course area immediately. If the race is restarted or resailed, she shall not sail in it.
- (c) If the race was completed but was later *abandoned* by the protest committee, and if the race is resailed, a board disqualified under rule B10.29(b) may sail in it.

30 STARTING PENALTIES

30.1 I Flag Rule

If flag I has been displayed, and any part of a board's hull, crew or equipment is on the course side of the starting line or one of its

extensions during the last minute before her starting signal, she shall sail across an extension to the pre-start side before *starting*.

30.2 Z Flag Rule

If flag Z has been displayed, no part of a board's hull, crew or equipment shall be in the triangle formed by the ends of the starting line and the first *mark* during the last minute before her starting signal. If a board breaks this rule and is identified, she shall receive, without a hearing, a 20% Scoring Penalty calculated as stated in rule 44.3(c). She shall be penalized even if the race is restarted or resailed, but not if it is *postponed* or *abandoned* before the starting signal. If she is similarly identified during a subsequent attempt to start the same race, she shall receive an additional 20% Scoring Penalty.

30.3 U Flag Rule

If flag U has been displayed, no part of a board's hull, crew or equipment shall be in the triangle formed by the ends of the starting line and the first *mark* during the last minute before her starting signal. If a board breaks this rule and is identified, she shall be disqualified without a hearing, but not if the race is restarted or resailed.

30.4 Black Flag Rule

If a black flag has been displayed, no part of a board's hull, crew or equipment shall be in the triangle formed by the ends of the starting line and the first *mark* during the last minute before her starting signal. If a board breaks this rule and is identified, she shall be disqualified without a hearing, even if the race is restarted or resailed, but not if it is *postponed* or *abandoned* before the starting signal. If a general recall is signalled or the race is *abandoned* after the starting signal, the race committee shall display her sail number before the next warning signal for that race, and if the race is restarted or resailed she shall not sail in it. If she does so, her disqualification shall not be excluded in calculating her series score.

31 [B3.31] TOUCHING A MARK

A board may touch a *mark* but shall not hold on to it.

32 SHORTENING OR ABANDONING AFTER THE START

32.1 After the starting signal, the race committee may shorten the course (display flag S with two sounds) or *abandon* the race (display flag N, N over H, or N over A, with three sounds),

- (a) because of foul weather,
- (b) because of insufficient wind making it unlikely that any board will *finish* within the time limit,

- (c) because a *mark* is missing or out of position, or
- (d) for any other reason directly affecting the safety or fairness of the competition.

In addition, the race committee may shorten the course so that other scheduled races can be sailed, or *abandon* the race because of an error in the starting procedure. However, after one board has sailed the course and *finished* within the time limit, if any, the race committee shall not *abandon* the race without considering the consequences for all boards in the race or series.

- 32.2** If the race committee signals a shortened course (displays flag S with two sounds), the finishing line shall be,
- (a) at a rounding *mark*, between the *mark* and a staff displaying flag S;
 - (b) a line the course requires boards to cross; or
 - (c) at a gate, between the gate *marks*.

The shortened course shall be signalled before the first board crosses the finishing line.

33 CHANGING THE NEXT LEG OF THE COURSE

The race committee may change a leg of the course that begins at a rounding *mark* or at a gate by changing the position of the next *mark* (or the finishing line) and signalling all boards before they begin the leg. The next *mark* need not be in position at that time.

- (a) If the direction of the leg will be changed, the signal shall be the display of flag C with repetitive sounds and one or both of
 - (1) the new compass bearing,
 - (2) a green triangle for a change to starboard or a red rectangle for a change to port.
- (b) If the length of the leg will be changed, the signal shall be the display of flag C with repetitive sounds and a ‘-’ if the length will be decreased or a ‘+’ if it will be increased.
- (c) Subsequent legs may be changed without further signalling to maintain the course shape.

34 MARK MISSING

If a *mark* is missing or out of position, the race committee shall, if possible,

- (a) replace it in its correct position or substitute a new one of similar appearance, or
- (b) substitute an object displaying flag M and make repetitive sound signals.

35 TIME LIMIT AND SCORES

If one board sails the course as required by rule 28 and *finishes* within the time limit, if any, all boards that *finish* shall be scored according to their finishing places unless the race is *abandoned*. If no board *finishes* within the time limit, the race committee shall *abandon* the race.

36 RACES RESTARTED OR RESAILED

If a race is restarted or resailed, a breach of a *rule* in the original race, or in any previous restart or resail of that race, shall not

- (a) prohibit a board from competing unless she has broken rule 29 or 30.4; or
- (b) cause a board to be penalized except under rule 30.2, 30.4 or 69 or under rule 14 when she has caused injury or serious damage.

37 [B10.37] ELIMINATION SERIES INCLUDING HEATS

Rule B10.37 applies in elimination series in which boards compete in heats.

37.1 Elimination Series Procedure

- (a) Competition shall take the form of one or more elimination series. Each of them shall consist of either rounds in a single elimination series where only a number of the best scorers advance, or rounds in a double elimination series where boards have more than one opportunity to advance.
- (b) Boards shall sail one against another in pairs, or in groups determined by the elimination ladder. The selected form of competition shall not be changed while a round remains uncompleted.

37.2 Seeding and Ranking Lists

- (a) When a seeding or ranking list is used to establish the heats of the first round, places 1–8 (four heats) or 1–16 (eight heats) shall be distributed evenly among the heats.
- (b) For a subsequent elimination series, if any, boards shall be reassigned to new heats according to the ranking in the previous elimination series.
- (c) The organizing authority's seeding decisions are final and are not grounds for a request for redress.

37.3 Heat Schedule

The schedule of heats shall be posted on the official notice board no later than 30 minutes before the starting signal for the first heat.

37.4 Advancement and Byes

- (a) In racing and expression competition, the boards in each heat to advance to the next round shall be announced by the race committee no later than 10 minutes before the starting signal for the first heat. The number advancing may be changed by the protest committee as a result of a redress decision.
- (b) In expression competition, any first-round byes shall be assigned to the highest-seeded boards.
- (c) In wave performance competition, only the winner of each heat shall advance to the next round.
- (d) In freestyle competition, boards shall advance to the next round as follows: from an eight-board heat, the best four advance, and the winner will sail against the fourth and the second against the third; from a four-board heat, the best two advance and will sail against each other.

37.5 Finals

- (a) The final shall consist of a maximum of three races. The race committee shall announce the number of races to be sailed in the final no later than 5 minutes before the warning signal for the first final race.
- (b) A runners-up final may be sailed after the final. All boards in the semi-final heats that failed to qualify for the final may compete in it.

38 [B11.38] EXPRESSION COMPETITION - REGISTRATION; COURSE AREA; HEAT DURATION

- (a) Boards shall register with the race committee the colours and other particulars of their sails, or their identification according to another method stated in the sailing instructions, no later than the starting signal for the heat two heats before their own.
- (b) The course area shall be defined in the sailing instructions and posted on the official notice board no later than 10 minutes before the starting signal for the first heat. A board shall be scored only while sailing in the course area.
- (c) Any change in heat duration shall be announced by the race committee no later than 15 minutes before the starting signal for the first heat in the next round.

- (d) Rule B10.37.4 applies.

39 [B12.Part2(e), (f), (g), (h)] RULES FOR SPEED COMPETITION

- (e) MAXIMUM NUMBER OF RUNS FOR EACH BOARD

The maximum number of runs that may be made by each board in a round shall be announced by the race committee no later than 15 minutes before the starting signal for the first round.

- (f) DURATION OF A ROUND

The duration of a round shall be announced by the race committee no later than 15 minutes before the starting signal for the next round.

- (g) CONDITIONS FOR ESTABLISHING A RECORD

The minimum distance for a world record is 500 meters. Other records may be established over shorter distances. The course shall be defined by posts and transits ashore or by buoys afloat. Transits shall not converge.

- (h) VERIFICATION RULES

- (1) An observer appointed by the World Sailing Speed Record Council shall be present and verify run times and speeds at world record attempts. The race committee shall verify run times and speeds at other record attempts.
- (2) A competitor shall not enter the timing control area or discuss any timing matter directly with the timing organization. Any timing question shall be directed to the race committee.

PART 4

OTHER REQUIREMENTS WHEN RACING

*Part 4 rules apply only to boards **racing** unless the rule states otherwise.*

40 PERSONAL FLOTATION DEVICES

When flag Y is displayed with one sound before or with the warning signal, competitors shall wear personal flotation devices, except briefly while changing or adjusting clothing or personal equipment. When flag Y is displayed ashore, this rule applies at all times while afloat. Wet suits and dry suits are not personal flotation devices.

41 OUTSIDE HELP

41.1 A board shall not receive help from any outside source, except

- (a) help for a crew member who is ill, injured or in danger;
- (b) after a collision, help from the crew of the other vessel to get clear;
- (c) help in the form of information freely available to all boards;
- (d) unsolicited information from a disinterested source, which may be another board in the same race.

However, a board that gains a significant advantage in the race from help received under rule 41(a) may be protested and penalized; any penalty may be less than disqualification.

41.2 [B11.41.2] (for Expression Competition)

An assistant may provide replacement equipment to a board. The assistant shall not interfere with other competing boards. A board whose assistant interferes with another board may be penalized at the discretion of the protest committee.

42 [B4.42] PROPULSION

A board shall be propelled only by the action of the wind on the sail, by the action of the water on the hull and by the unassisted actions of the competitor. However, significant progress shall not be made by paddling, swimming or walking.

43 COMPETITOR CLOTHING AND EQUIPMENT

43.1 (a) [B4.43.1(a)] Competitors shall not wear or carry clothing or equipment for the purpose of increasing their weight. However, a competitor may wear a drinking container that shall have a capacity of at least one litre and weigh no more than 1.5 kilograms when full.

(b) Furthermore, a competitor's clothing and equipment shall not weigh more than 8 kilograms, excluding a hiking or trapeze harness and clothing (including footwear) worn only below the knee. Class rules or sailing instructions may specify a lower weight or a higher weight up to 10 kilograms. Class rules may include footwear and other clothing worn below the knee within that weight. A hiking or trapeze harness shall have positive buoyancy and shall not weigh more than 2 kilograms, except that class rules may specify a higher weight up to 4 kilograms. Weights shall be determined as required by Appendix H.

43.2 Deleted

44 PENALTIES AT THE TIME OF AN INCIDENT

44.1 [B4.44.1] Taking a Penalty

A board may take a 360°-Turn Penalty when she may have broken one of more rules of Part 2 in an incident while *racing*. The sailing instructions may specify the use of some other penalty. However, if the board caused injury or serious damage or, despite taking a penalty, gained a significant advantage in the race or series by her breach, her penalty shall be to retire.

44.2 [B4.44.2] 360°-Turn Penalty

After getting well clear of other boards as soon after the incident as possible, a board takes a 360°-Turn Penalty by promptly making a 360° turn with no requirement for a tack or a gybe. When a board takes the penalty at or near the finishing line, she shall sail completely to the course side of the line before *finishing*.

44.3 Deleted

45 Deleted

46 PERSON IN CHARGE

A board shall have on board a person in charge designated by the member or organization that entered the board. See rule 75.

47 Deleted

48 FOG SIGNALS AND LIGHTS; TRAFFIC SEPARATION SCHEMES

48.1 Deleted

48.2 A board shall comply with rule 10, Traffic Separation Schemes, of the *IRPCAS*.

49 Deleted

50 Deleted

51 Deleted

52 Deleted

53 SKIN FRICTION

A board shall not eject or release a substance, such as a polymer, or have specially textured surfaces that could improve the character of the flow of water inside the boundary layer.

54 Deleted

55 TRASH DISPOSAL

A competitor shall not intentionally put trash in the water. This rule applies at all times while afloat. The penalty for a breach of this rule may be less than disqualification.

PART 5

PROTESTS, REDRESS, HEARINGS, MISCONDUCT AND APPEALS

SECTION A

PROTESTS; REDRESS; RULE 69 ACTION

60 RIGHT TO PROTEST; RIGHT TO REQUEST REDRESS OR RULE 69 ACTION

60.1 [B.60.1(a)] A board may

- (a) protest another board, but not for an alleged breach of a rule of Part 2 or rule 31 unless she was involved in the incident; or
- (b) request redress.

60.2 A race committee may

- (a) protest a board, but not as a result of information arising from a request for redress or an invalid *protest*, or from a report from a person with a *conflict of interest* other than the representative of the board herself;
- (b) request redress for a board; or
- (c) report to the protest committee requesting action under rule 69.2(b).

60.3 A protest committee may

- (a) protest a board, but not as a result of information arising from a request for redress or an invalid *protest*, or from a report from a person with a *conflict of interest* other than the representative of the board herself. However, it may protest a board
 - (1) if it learns of an incident involving her that may have resulted in injury or serious damage, or
 - (2) if during the hearing of a valid *protest* it learns that the board, although not a *party* to the hearing, was involved in the incident and may have broken a *rule*;
- (b) call a hearing to consider redress;
- (c) act under rule 69.2(b); or
- (d) call a hearing to consider whether a *support person* has broken a *rule*, based on its own observation or information received from any source, including evidence taken during a hearing.

60.4 A technical committee may

- (a) protest a board, but not as a result of information arising from a request for redress or an invalid *protest*, or from a report from a person with a *conflict of interest* other than the representative of the board herself. However, it shall protest a board if it decides that
 - (1) a board has broken a rule of Part 4, but not rules 41, 42, 44 and 46, or
 - (2) a board or personal equipment does not comply with the class rules;
- (b) request redress for a board; or
- (c) report to the protest committee requesting action under rule 69.2(b).

60.5 However, neither a board nor a committee may protest for an alleged breach of rule 5, 6, 7 or 69.

61 PROTEST REQUIREMENTS

61.1 [B.61.1] Informing the Protestee

- (a) A board intending to protest shall inform the other board at the first reasonable opportunity. When her *protest* will concern an incident in the racing area that she was involved in, she shall hail 'Protest'. She shall also inform the race committee of her intention to protest as soon as practicable after she *finishes* or retires. However,
 - (1) if the other board is beyond hailing distance, the protesting board need not hail but she shall inform the other board at the first reasonable opportunity;
 - (2) if the hull length of the protesting boat is less than 6 metres, she need not display a red flag;
 - (3) if the incident was an error by the other board in sailing the course, she need not hail or display a red flag but she shall inform the other board either before or at the first reasonable opportunity after the other board *finishes*;
 - (4) if as a result of the incident a competitor of either board is in danger, or there is injury or serious damage that is obvious to the board intending to protest, the requirements of this rule do not apply to her, but she shall attempt to inform the other board within the time limit of rule 61.3.
- (b) If the race committee, technical committee or protest committee intends to protest a board concerning an incident the committee

observed in the racing area, it shall inform her after the race within the time limit of rule 61.3. In other cases, the committee shall inform the board of its intention to protest as soon as reasonably possible.

- (c) If the protest committee decides to protest a board under rule 60.3(a)(2), it shall inform her as soon as reasonably possible, close the current hearing, proceed as required by rules 61.2 and 63, and hear the original and the new *protests* together.

61.2 Protest Contents

A *protest* shall be in writing and identify

- (a) the protestor and protestee;
- (b) the incident;
- (c) where and when the incident occurred;
- (d) any *rule* the protestor believes was broken; and
- (e) the name of the protestor's representative.

However, if requirement (b) is met, requirement (a) may be met at any time before the hearing, and requirements (d) and (e) may be met before or during the hearing. Requirement (c) may also be met before or during the hearing, provided the protestee is allowed reasonable time to prepare for the hearing.

61.2 [B.10.63] Deleted (for events that include elimination)

61.3 Protest Time Limit

A *protest* by a board, or by the race committee, technical committee or protest committee about an incident the committee observed in the racing area, shall be delivered to the race office within the protest time limit stated in the sailing instructions. If none is stated, the time limit is two hours after the last board in the race *finishes*. Other race committee, technical committee or protest committee *protests* shall be delivered to the race office no later than two hours after the committee receives the relevant information. The protest committee shall extend the time if there is good reason to do so.

61.3 [B10.63.6] Deleted (for events that include elimination)

62 REDRESS

- 62.1 A request for redress or a protest committee's decision to consider redress shall be based on a claim or possibility that a board's score or place in a race or series has been or may be, through no fault of her own, made significantly worse by

- (a) an improper action or omission of the race committee, protest committee, organizing authority or technical committee for the event, but not by a protest committee decision when the board was a *party* to the hearing;
- (b) [B.62.1(b)] injury, physical damage or *capsize* because of the action of
 - (1) a board that broke a rule of Part 2 and took the appropriate penalty or was penalized, or
 - (2) a vessel not *racing* that was required to keep clear.
- (c) giving help (except to herself) in compliance with rule 1.1; or
- (d) an action of a boat, or a competitor of her, that resulted in a penalty under rule 2 or a penalty or warning under rule 69.2(h).

62.2 A request shall be in writing and identify the reason for making it. If the request is based on an incident in the racing area, it shall be delivered to the race office within the protest time limit or two hours after the incident, whichever is later. Other requests shall be delivered as soon as reasonably possible after learning of the reasons for making the request. The protest committee shall extend the time if there is good reason to do so. No red flag is required.

62.2 [B.10.63.6] **Deleted** (for events that include elimination)

SECTION B

HEARINGS AND DECISIONS

63 HEARINGS

63 [B.10.63] For a race of an elimination series that will qualify a board to compete in a later stage of an event, rules 61.2 and 65.2 are deleted and rule 63.6 is changed.

63.1 Requirement for a Hearing

A board or competitor shall not be penalized without a protest hearing, except as provided in rules 30.2, 30.3, 30.4, 64.3(d), 69, 78.2, A5 and P2. A decision on redress shall not be made without a hearing. The protest committee shall hear all *protests* and requests for redress that have been delivered to the race office unless it allows a *protest* or request to be withdrawn.

63.2 Time and Place of the Hearing; Time for Parties to Prepare

All *parties* to the hearing shall be notified of the time and place of the hearing, the *protest* or redress information shall be made available to

them, and they shall be allowed reasonable time to prepare for the hearing.

63.2 [B10.63.6] Deleted (for events that include elimination)

63.3 Right to Be Present

- (a) A representative of each *party* to the hearing has the right to be present throughout the hearing of all the evidence. When a *protest* claims a breach of a rule of Part 2, 3 or 4, the representatives of boards shall have been on board at the time of the incident, unless there is good reason for the protest committee to rule otherwise. Any witness, other than a member of the protest committee, shall be excluded except when giving evidence.
- (b) If a *party* to the hearing of a *protest* or request for redress does not come to the hearing, the protest committee may nevertheless decide the *protest* or request. If the *party* was unavoidably absent, the committee may reopen the hearing.

63.4 Conflict of Interest

- (a) A protest committee member shall declare any possible *conflict of interest* as soon as he is aware of it. A *party* to the hearing who believes a member of the protest committee has a *conflict of interest* shall object as soon as possible. A *conflict of interest* declared by a protest committee member shall be included in the written information provided under rule 65.2.
- (b) A member of a protest committee with a *conflict of interest* shall not be a member of the committee for the hearing, unless
 - (1) all *parties* consent, or
 - (2) the protest committee decides that the *conflict of interest* is not significant.
- (c) When deciding whether a *conflict of interest* is significant, the protest committee shall consider the views of the *parties*, the level of the conflict, the level of the event, the importance to each *party*, and the overall perception of fairness.
- (d) However, for World Sailing major events, or for other events as prescribed by the national authority of the venue, rule 63.4(b) does not apply and a person who has a *conflict of interest* shall not be a member of the protest committee.

63.5 Validity of the Protest or Request for Redress

At the beginning of the hearing the protest committee shall take any evidence it considers necessary to decide whether all requirements for the *protest* or request for redress have been met. If they have been met,

the *protest* or request is valid and the hearing shall be continued. If not, the committee shall declare the *protest* or request invalid and close the hearing. If the *protest* has been made under rule 60.3(a)(1), the committee shall also determine whether or not injury or serious damage resulted from the incident in question. If not, the hearing shall be closed.

63.6 Taking Evidence and Finding Facts

The protest committee shall take the evidence of the *parties* present at the hearing and of their witnesses and other evidence it considers necessary. A member of the protest committee who saw the incident shall, while the *parties* are present, state that fact and may give evidence. A *party* present at the hearing may question any person who gives evidence. The committee shall then find the facts and base its decision on them.

63.6 [B.10.63] Taking Evidence and Finding Facts (for Elimination Series)

Protests and requests for redress need not be in writing; they shall be made orally to a member of the protest committee as soon as reasonably possible following the race. The protest committee may take evidence in any way it considers appropriate and may communicate its decision orally.

63.7 Conflict Between Rules

If there is a conflict between two or more *rules* that must be resolved before the protest committee makes a decision, the committee shall apply the *rule* that it believes will provide the fairest result for all boards affected. Rule 63.7 applies only if the conflict is between rules in the notice of race, the sailing instructions, or any of the other documents that govern the event under item (g) of the definition *Rule*.

63.8 Protests Between Boards in Different Races

A *protest* between boards sailing in different races conducted by different organizing authorities shall be heard by a protest committee acceptable to those authorities.

64 DECISIONS

64.1 Penalties and Exoneration

When the protest committee decides that a board that is a *party* to a protest hearing has broken a *rule* and is not exonerated, it shall disqualify her unless some other penalty applies. A penalty shall be imposed whether or not the applicable *rule* was mentioned in the *protest*. If a board has broken a *rule* when not *racing*, her penalty shall apply to the race sailed nearest in time to that of the incident. However,

- (a) when as a consequence of breaking a *rule* a board has compelled another board to break a *rule*, the other board shall be exonerated.
- (b) if a board has taken an applicable penalty, she shall not be further penalized under this rule unless the penalty for a *rule* she broke is a disqualification that is not excludable from her series score.
- (c) if the race is restarted or resailed, rule 36 applies.

64.1 [B12.64.1] Penalties for Speed events

Rule 64.1 is deleted and replaced by:

- (a) If a board fails to comply with a rule, she may be warned. If a board is warned a second time during the same round, she shall be excluded by the race committee from the remainder of the round. A list of the sail numbers of boards that have received warnings or have been excluded shall be posted on a notice board near the finishing line.
- (b) A board observed in the course area after having been excluded from a round shall be excluded from the competition without a hearing, and none of her previous times or results shall be valid.
- (c) Any breach of the verification rules may result in exclusion from one or more rounds or from the competition.
- (d) **[B12.Part2 (c)] Course Control**
When the race committee points an orange flag at a board, she is penalized and run shall not be counted.

64.2 Decisions on Redress

When the protest committee decides that a board is entitled to redress under rule 62, it shall make as fair an arrangement as possible for all boards affected, whether or not they asked for redress. This may be to adjust the scoring (see rule A10 for some examples) or finishing times of boards, to *abandon* the race, to let the results stand or to make some other arrangement. When in doubt about the facts or probable results of any arrangement for the race or series, especially before *abandoning* the race, the protest committee shall take evidence from appropriate sources.

64.3 Decisions on Protests Concerning Class Rules

- (a) When the protest committee finds that deviations in excess of tolerances specified in the class rules were caused by damage or normal wear and do not improve the performance of the board, it shall not penalize her. However, the board shall not *race* again until the deviations have been corrected, except when the protest committee decides there is or has been no reasonable opportunity to do so.

- (b) **[B5.64.3(b)]** When the protest committee is in doubt about a matter concerning the measurement of a board, the meaning of a class rule, or damage to a board, it shall refer its questions, together with the relevant facts, to an authority responsible for interpreting the rule. In making its decision, the committee shall be bound by the reply of the authority.
- (c) When a board is penalized under a class rule and the protest committee decides that the board also broke the same rule in earlier races in the same event, the penalty may be imposed for all such races. No further *protest* is necessary.
- (d) When a board penalized under a class rule states in writing that she intends to appeal, she may compete in subsequent races without changes to the board. However, if she fails to appeal or the appeal is decided against her, she shall be disqualified without a further hearing from all subsequent races in which she competed.
- (e) Measurement costs arising from a *protest* involving a class rule shall be paid by the unsuccessful *party* unless the protest committee decides otherwise.

64.4 Decisions Concerning Support Persons

- (a) When the protest committee decides that a *support person* who is a *party* to a hearing has broken a *rule*, it may
 - (1) issue a warning,
 - (2) exclude the person from the event or venue or remove any privileges or benefits, or
 - (3) take other action within its jurisdiction as provided by the *rules*.
- (b) The protest committee may also penalize a competitor for the breach of a *rule* by a *support person* by changing the board's score in a single race, up to and including DSQ, when the protest committee decides that
 - (1) the competitor may have gained a competitive advantage as the result of the breach by the *support person*, or
 - (2) the *support person* commits a further breach after the competitor has been warned by the protest committee that a penalty may be imposed.

65 INFORMING THE PARTIES AND OTHERS

- 65.1** After making its decision, the protest committee shall promptly inform the *parties* to the hearing of the facts found, the applicable *rules*, the decision, the reasons for it, and any penalties imposed or redress given.

65.2 A *party* to the hearing is entitled to receive the above information in writing, provided she asks for it in writing from the protest committee no later than seven days after being informed of the decision. The committee shall then promptly provide the information, including, when relevant, a diagram of the incident prepared or endorsed by the committee.

65.2 [B.10.63] **Deleted** (for events that include elimination)

65.3 When the protest committee penalizes a board under a class rule, it shall send the above information to the relevant class rule authorities.

66 REOPENING A HEARING

The protest committee may reopen a hearing when it decides that it may have made a significant error, or when significant new evidence becomes available within a reasonable time. It shall reopen a hearing when required by the national authority under rule 71.2 or R5. A *party* to the hearing may ask for a reopening no later than 24 hours after being informed of the decision. On the last scheduled day of racing the request shall be delivered

- (a) within the protest time limit if the requesting *party* was informed of the decision on the previous day;
- (b) no later than 30 minutes after the *party* was informed of the decision on that day.

When a hearing is reopened, a majority of the members of the protest committee shall, if possible, be members of the original protest committee.

67 [Prescription of IWA] DAMAGES

67.1 Any claim for damages arising from an incident while the board is bound by Windsurfing Competition Rules shall be subject to the jurisdiction of the courts or insurance companies and not consider by the protest committee.

67.2 A board that takes a penalty or retires does not thereby admit liability for damages or that she has broken a rule.

SECTION C

MISCONDUCT

69 MISCONDUCT

69.1 Obligation not to Commit Misconduct; Resolution

- (a) A competitor, board owner or *support person* shall not commit an act of misconduct.
- (b) Misconduct is:
 - (1) conduct that is a breach of good manners, a breach of good sportsmanship, or unethical behavior; or
 - (2) conduct that may bring the sport into disrepute.
- (c) An allegation of a breach of rule 69.1(a) shall be resolved in accordance with the provisions of rule 69. It shall not be grounds for a *protest* and rule 63.1 does not apply.

69.2 Action by a Protest Committee

- (a) A protest committee acting under this rule shall have at least three members.
- (b) When a protest committee, from its own observation or from information received from any source, including evidence taken during a hearing, believes a person may have broken rule 69.1(a), it shall decide whether or not to call a hearing.
- (c) When the protest committee needs more information to make the decision to call a hearing, it shall consider appointing a person or persons to conduct an investigation. These investigators shall not be members of the protest committee that will decide the matter.
- (d) When an investigator is appointed, all relevant information he gathers, favourable or unfavourable, shall be disclosed to the protest committee, and if the protest committee decides to call a hearing, to the *parties*.
- (e) If the protest committee decides to call a hearing, it shall promptly inform the person in writing of the alleged breach and of the time and place of the hearing and follow the procedures in rules 63.2, 63.3(a), 63.4 and 63.6 except that:
 - (1) unless a person has been appointed by World Sailing, a person may be appointed by the protest committee to present the allegation.
 - (2) a person against whom an allegation has been made under this rule shall be entitled to have an advisor and a representative with him who may act on his behalf.

- (f) If the person is unable to attend the hearing and
 - (1) provides good reason, the protest committee shall reschedule it; or
 - (2) does not provide good reason and does not come to it, the protest committee may conduct it without the person present.
- (g) The standard of proof to be applied is the test of the comfortable satisfaction of the protest committee, bearing in mind the seriousness of the alleged misconduct. However, if the standard of proof in this rule conflicts with the laws of a country, the national authority may, with the approval of World Sailing, change it with a prescription to this rule.
- (h) When the protest committee decides that a competitor or board owner has broken rule 69.1(a), it may take one or more of the following actions
 - (1) issue a warning;
 - (2) change their board's score in one or more races, including disqualification(s) that may or may not be excluded from her series score;
 - (3) exclude the person from the event or venue or remove any privileges or benefits; and
 - (4) take any other action within its jurisdiction as provided by the *rules*.
- (i) When the protest committee decides that a *support person* has broken rule 69.1(a), rule 64.4 applies.
- (j) If the protest committee
 - (1) imposes a penalty greater than one DNE;
 - (2) excludes the person from the event or venue; or
 - (3) in any other case if it considers it appropriate,it shall report its findings, including the facts found, its conclusions and decision to the national authority of the person or, for specific international events listed in the World Sailing Regulations, to World Sailing. If the protest committee has acted under rule 69.2(f)(2), the report shall also include that fact and the reasons for it.
- (k) If the protest committee decides not to conduct the hearing without the person present, or if the protest committee has left the event and a report alleging a breach of rule 69.1(a) is received, the race committee or organizing authority may appoint the same or a new protest committee to proceed under this rule. If it is impractical for the protest committee to conduct a hearing, it shall collect all

available information and, if the allegation seems justified, make a report to the national authority of the person or, for specific international events listed in the World Sailing Regulations, to World Sailing.

69.3 Action by a National Authority and World Sailing

The disciplinary powers, procedures and responsibilities of national authorities and World Sailing that apply are specified in World Sailing Regulation 35, Disciplinary Code. National authorities and World Sailing may impose further penalties, including suspension of eligibility, under that regulation.

SECTION D APPEALS

70 APPEALS AND REQUESTS TO A NATIONAL AUTHORITY

- 70.1** (a) Provided that the right of appeal has not been denied under rule 70.5, a *party* to a hearing may appeal a protest committee's decision or its procedures, but not the facts found.
- (b) A board may appeal when she is denied a hearing required by rule 63.1.
- 70.2** A protest committee may request confirmation or correction of its decision.
- 70.3** An appeal under rule 70.1 or a request by a protest committee under rule 70.2 shall be sent to the national authority with which the organizing authority is associated under rule 89.1. However, if boards will pass through the waters of more than one national authority while *racing*, the sailing instructions shall identify the national authority to which appeals or requests are required to be sent.
- 70.4** A club or other organization affiliated to a national authority may request an interpretation of the *rules*, provided that no *protest* or request for redress that may be appealed is involved. The interpretation shall not be used for changing a previous protest committee decision.
- 70.5** There shall be no appeal from the decisions of an international jury constituted in compliance with Appendix N. Furthermore, if the notice of race and the sailing instructions so state, the right of appeal may be denied provided that
- (a) it is essential to determine promptly the result of a race that will qualify a board to compete in a later stage of an event or a

subsequent event (a national authority may prescribe that its approval is required for such a procedure);

- (b) a national authority so approves for a particular event open only to entrants under its own jurisdiction; or
- (c) a national authority after consultation with World Sailing so approves for a particular event, provided the protest committee is constituted as required by Appendix N, except that only two members of the protest committee need be International Judges.

70.6 Appeals and requests shall conform to Appendix R.

70.7 [B10.70.7] Appeals are not permitted in disciplines and formats with elimination series.

71 NATIONAL AUTHORITY DECISIONS

71.1 A person who has a *conflict of interest* or was a member of the protest committee shall not take any part in the discussion or decision on an appeal or a request for confirmation or correction.

71.2 The national authority may uphold, change or reverse a protest committee's decision including a decision on validity or a decision under rule 69. Alternatively, the national authority may order that a hearing be reopened, or that a new hearing be held by the same or a different protest committee. When the national authority decides that there shall be a new hearing, it may appoint the protest committee.

71.3 When from the facts found by the protest committee the national authority decides that a board that was a *party* to a protest hearing broke a *rule* and is not exonerated, it shall penalize her, whether or not that board or that *rule* was mentioned in the protest committee's decision.

71.4 The decision of the national authority shall be final. The national authority shall send its decision in writing to all *parties* to the hearing and the protest committee, who shall be bound by the decision.

PART 6

ENTRY AND QUALIFICATION

75 ENTERING A RACE

- 75.1** To enter a race, a board shall comply with the requirements of the organizing authority of the race. She shall be entered by
- (a) a member of a club or other organization affiliated to a World Sailing member national authority,
 - (b) such a club or organization, or
 - (c) a member of a World Sailing member national authority.
- 75.2** Competitors shall comply with World Sailing Regulation 19, Eligibility Code.

76 EXCLUSION OF BOARDS OR COMPETITORS

- 76.1** The organizing authority or the race committee may reject or cancel the entry of a board or exclude a competitor, subject to rule 76.3, provided it does so before the start of the first race and states the reason for doing so. On request the board shall promptly be given the reason in writing. The board may request redress if she considers that the rejection or exclusion is improper.
- 76.2** The organizing authority or the race committee shall not reject or cancel the entry of a board or exclude a competitor because of advertising, provided the board or competitor complies with World Sailing Regulation 20, Advertising Code.
- 76.3** At world and continental championships no entry within stated quotas shall be rejected or cancelled without first obtaining the approval of the relevant World Sailing Class Association (or the Offshore Racing Council) or World Sailing.

77 IDENTIFICATION ON SAILS

A board shall comply with the requirements of Appendix G governing class insignia, national letters and numbers on sails.

78 COMPLIANCE WITH CLASS RULES; CERTIFICATES

- 78.1** [B6.78.1] While a board is *racing*, her owner and any other person in charge shall ensure that the board is maintained to comply with her class rules and that her measurement or rating certificate, if any, remains valid. In addition, the board shall also comply at other times specified in the class rules, the notice of race or the sailing instructions. When so prescribed by World Sailing, a numbered and dated device on a board

and her centreboard, fin and rig shall serve as her measurement certificate.

78.2 When a *rule* requires a valid certificate to be produced or its existence verified before a board *races*, and this cannot be done, the board may *race* provided that the race committee receives a statement signed by the person in charge that a valid certificate exists. The board shall produce the certificate or arrange for its existence to be verified by the race committee. The penalty for breaking this rule is disqualification without a hearing from all races of the event.

79 CLASSIFICATION

If the notice of race or class rules state that some or all competitors must satisfy classification requirements, the classification shall be carried out as described in World Sailing Regulation 22, Sailor Classification Code.

80 ADVERTISING

A board and her crew shall comply with World Sailing Regulation 20, Advertising Code.

81 RESCHEDULED EVENT

When an event is rescheduled to dates different from the dates stated in the notice of race, all boards entered shall be notified. The race committee may accept new entries that meet all the entry requirements except the original deadline for entries.

PART 7

RACE ORGANIZATION

84 GOVERNING RULES

The organizing authority, race committee, technical committee, protest committee and other race officials shall be governed by the *rules* in the conduct and judging of races.

85 CHANGES TO RULES

85.1 A change to a *rule* shall refer specifically to the *rule* and state the change. A change to a *rule* includes an addition to it or deletion of all or part of it.

85.2 A change to one of the following types of *rules* may be made only as shown below.

<i>Type of rule</i>	<i>Change only if permitted by</i>
Racing rule	Rule 86
Rule in a World Sailing code	A rule in the code
National authority prescription	Rule 88.2
Class rule	Rule 87
Rule in the notice of race	Rule 89.2(b)
Rule in the sailing instructions	Rule 90.2(c)
Rule in any other document governing the event	A rule in the document itself

86 CHANGES TO THE RACING RULES

86.1 A racing rule shall not be changed unless permitted in the rule itself or as follows:

- (a) Prescriptions of a national authority may change a racing rule, but not the Definitions; the Basic Principles; a rule in the Introduction; Part 1, 2 or 7; rule 42, 43, 63.4, 69, 70, 71, 75, 76.3, 79 or 80; a rule of an appendix that changes one of these rules; Appendix H or N; World Sailing Regulation 19, 20, 21, 22, 35 or 37.
- (b) The notice of race or sailing instructions may change a racing rule, but not rule 76.1 or 76.2, Appendix R, or a rule listed in rule 86.1(a).
- (c) Class rules may change only racing rules 42, 49, 50, 51, 52, 53 and 54.

86.2 In exception to rule 86.1, World Sailing may in limited circumstances (see World Sailing Regulation 28.1.3) authorize changes to the racing rules for a specific international event. The authorization shall be stated in a letter of approval to the event organizing authority and in the notice of race and sailing instructions, and the letter shall be posted on the event's official notice board.

86.3 If a national authority so prescribes, the restrictions in rule 86.1 do not apply if rules are changed to develop or test proposed rules. The national authority may prescribe that its approval is required for such changes.

87 CHANGES TO CLASS RULES

The notice of race or sailing instructions may change a class rule only when the class rules permit the change, or when written permission of the class association for the change is displayed on the official notice board.

88 NATIONAL PRESCRIPTIONS

88.1 Prescriptions that Apply

The prescriptions that apply to an event are the prescriptions of the national authority with which the organizing authority is associated under rule 89.1. However, if boards will pass through the waters of more than one national authority while *racing*, the notice of race or sailing instructions shall identify the prescriptions that will apply and when they will apply.

88.2 Changes to Prescriptions

The notice of race or sailing instructions may change a prescription. However, a national authority may restrict changes to its prescriptions with a prescription to this rule, provided World Sailing approves its application to do so. The restricted prescriptions shall not be changed.

89 ORGANIZING AUTHORITY; NOTICE OF RACE; APPOINTMENT OF RACE OFFICIALS

89.1 Organizing Authority

Races shall be organized by an organizing authority, which shall be

- (a) World Sailing;
- (b) a member national authority of World Sailing;
- (c) an affiliated club;
- (d) an affiliated organization other than a club and, if so prescribed by the national authority, with the approval of the national authority or in conjunction with an affiliated club;

- (e) an unaffiliated class association, either with the approval of the national authority or in conjunction with an affiliated club;
- (f) two or more of the above organizations;
- (g) an unaffiliated body in conjunction with an affiliated club where the body is owned and controlled by the club. The national authority of the club may prescribe that its approval is required for such an event; or
- (h) if approved by World Sailing and the national authority of the club, an unaffiliated body in conjunction with an affiliated club where the body is not owned and controlled by the club.

In rule 89.1, an organization is affiliated if it is affiliated to the national authority of the venue; otherwise the organization is unaffiliated. However, if boards will pass through the waters of more than one national authority while *racing*, an organization is affiliated if it is affiliated to the national authority of one of the ports of call.

89.2 Notice of Race; Appointment of Race Officials

- (a) The organizing authority shall publish a notice of race that conforms to rule J1.
- (b) The notice of race may be changed provided adequate notice is given.
- (c) The organizing authority shall appoint a race committee and, when appropriate, appoint a protest committee, a technical committee and umpires. However, the race committee, an international jury, a technical committee and umpires may be appointed by World Sailing as provided in its regulations.

90 RACE COMMITTEE; SAILING INSTRUCTIONS; SCORING

90.1 Race Committee

The race committee shall conduct races as directed by the organizing authority and as required by the *rules*.

90.2 [B7.90.2] Sailing Instructions

- (a) The race committee shall publish written sailing instructions that conform to rule J2.
- (b) When appropriate, for an event where entries from other countries are expected, the sailing instructions shall include, in English, the applicable national prescriptions.
- (c) The sailing instructions may be changed provided the change is in writing and posted on the official notice board before the time stated in the sailing instructions or, on the water, communicated to

each board before her warning signal. Oral instructions may be given only if the procedure is stated in the sailing instructions.

90.3 Scoring

- (a) The race committee shall score a race or series as provided in Appendix A using the Low Point System, unless the notice of race or sailing instructions specify some other system. A race shall be scored if it is not *abandoned* and if one board sails the course in compliance with rule 28 and *finishes* within the time limit, if any, even if she retires after *finishing* or is disqualified.
- (b) When a scoring system provides for excluding one or more race scores, any score that is a Disqualification Not Excludable (DNE) shall be included in a board's series score.
- (c) When the race committee determines from its own records or observations that it has scored a board incorrectly, it shall correct the error and make the corrected scores available to competitors.

91 PROTEST COMMITTEE

A protest committee shall be

- (a) a committee appointed by the organizing authority or race committee;
- (b) an international jury appointed by the organizing authority or as prescribed in the World Sailing Regulations. It shall be composed as required by rule N1 and have the authority and responsibilities stated in rule N2. A national authority may prescribe that its approval is required for the appointment of international juries for races within its jurisdiction, except World Sailing events or when international juries are appointed by World Sailing under rule 89.2(c); or
- (c) a committee appointed by the national authority under rule 71.2.

92 TECHNICAL COMMITTEE

92.1 A technical committee shall be a committee of at least one member and be appointed by the organizing authority or the race committee or as prescribed in the World Sailing Regulations.

92.2 The technical committee shall conduct equipment inspection and event measurement as directed by the organizing authority and as required by the *rules*.

APPENDIX A

SCORING

See rule 90.3.

A1 [B8.A1] NUMBER OF RACES; OVERALL SCORES

The number of races scheduled and the number required to be completed to constitute a series shall be stated in the notice of race or sailing instructions. If an event includes more than one discipline or format, the notice of race or sailing instructions shall state how the overall scores are to be calculated.

A2 SERIES SCORES

A2.1 [B8.A2.1] SERIES SCORES

Each board's series score shall, subject to rule 90.3(b), be the total of her race scores excluding her

- (a) worst score when from 5 to 11 races have been completed, or
- (b) two worst scores when 12 or more races have been completed.

(The notice of race or sailing instructions may make a different arrangement. A race is completed if scored; see rule 90.3(a).) If a board has two or more equal worst scores, the score(s) for the race(s) sailed earliest in the series shall be excluded. The board with the lowest series score wins and others shall be ranked accordingly.

A2.1 [B10.A2.1] Each board's elimination series score shall, subject to rule 90.3(b), be the total of her race scores excluding her

- (a) worst score when 3 or 4 races are completed,
- (b) two worst scores when from 5 to 7 races are completed,
- (c) three worst scores when 8 or more races are completed.

Each board's final series score shall be the total of her race scores excluding her worst score when 3 races are completed.

(The notice of race or sailing instructions may make a different arrangement. A race is completed if scored; see rule 90.3(a).) If a board has two or more equal worst scores, the score(s) for the race(s) sailed earliest in the series shall be excluded. The board with the lowest series score wins and others shall be ranked accordingly.

A2.2 If a board has entered any race in a series, she shall be scored for the whole series.

A3 STARTING TIMES AND FINISHING PLACES

The time of a board's starting signal shall be her starting time, and the order in which boards *finish* a race shall determine their finishing places. However, when a handicap or rating system is used a board's corrected time shall determine her finishing place.

A4 LOW POINT SYSTEM

The Low Point System will apply unless the notice of race or sailing instructions specify another system; see rule 90.3(a).

A4.1 Each board *starting* and *finishing* and not thereafter retiring, being penalized or given redress shall be scored points as follows:

<i>Finishing place</i>	<i>Points</i>
First	1
Second	2
Third	3
Fourth	4
Fifth	5
Sixth	6
Seventh	7
Each place thereafter	Add 1 point

A4.2 A board that did not *start*, did not *finish*, retired or was disqualified shall be scored points for the finishing place one more than the number of boards entered in the series or, in a race of an elimination series, the number of boards in that heat. A board that is penalized under rule 30.2 or that takes a penalty under rule 44.3(a) shall be scored points as provided in rule 44.3(c).

A4.3 [B10.A4.3] When a heat cannot be completed, the points for the unscored places shall be added together and divided by the number of places in that heat. The resulting number of points, to the nearest tenth of a point (0.05 to be rounded upward), shall be given to each board entered in the heat.

A5 SCORES DETERMINED BY THE RACE COMMITTEE

A board that did not *start* or *finish* or comply with rule 30.2, 30.3, 30.4 or 78.2, or that retires or takes a penalty under rule 44.3(a), shall be scored accordingly by the race committee without a hearing. Only the protest committee may take other scoring actions that worsen a board's score.

A6 CHANGES IN PLACES AND SCORES OF OTHER BOARDS

- A6.1** If a board is disqualified from a race or retires after *finishing*, each board with a worse finishing place shall be moved up one place.
- A6.2** If the protest committee decides to give redress by adjusting a board's score, the scores of other boards shall not be changed unless the protest committee decides otherwise.

A7 RACE TIES

If boards are tied at the finishing line or if a handicap or rating system is used and boards have equal corrected times, the points for the place for which the boards have tied and for the place(s) immediately below shall be added together and divided equally. Boards tied for a race prize shall share it or be given equal prizes.

A8 [B8.A8] SERIES TIES

- A8.1** If there is a series-score tie between two or more boards, they shall be ranked in order of their best excluded race score.
- A8.2** If a tie remains between two or more boards, each board's race scores, including excluded scores, shall be listed in order of best to worst, and at the first point(s) where there is a difference the tie shall be broken in favour of the board(s) with the best score(s). These scores shall be used even if some of them are excluded scores.
- A8.3** If a tie still remains between two or more boards, they shall be ranked in order of their scores in the last race. Any remaining ties shall be broken by using the tied boards' scores in the next-to-last race and so on until all ties are broken. These scores shall be used even if some of them are excluded.

A9 RACE SCORES IN A SERIES LONGER THAN A REGATTA

For a series that is held over a period of time longer than a regatta, a board that came to the starting area but did not *start*, did not *finish*, retired or was disqualified shall be scored points for the finishing place one more than the number of boards that came to the starting area. A board that did not come to the starting area shall be scored points for the finishing place one more than the number of boards entered in the series.

A10 GUIDANCE ON REDRESS

If the protest committee decides to give redress by adjusting a board's score for a race, it is advised to consider scoring her

- (a) points equal to the average, to the nearest tenth of a point (0.05 to be rounded upward), of her points in all the races in the series

- except the race in question;
- (b) points equal to the average, to the nearest tenth of a point (0.05 to be rounded upward), of her points in all the races before the race in question; or
 - (c) points based on the position of the board in the race at the time of the incident that justified redress.

APPENDIX A – SCORING IN EXPRESSION COMPETITION

The rules of Appendix A are deleted and replaced by:

A1 [B11.A1] EXPRESSION COMPETITION SCORING

- (a) Expression competition shall be scored by a panel of three judges. However, the panel may have a greater odd number of members, and there may be two such panels. Each judge shall give points for each manoeuvre based on the scale stated in the notice of race or sailing instructions.
- (b) The criteria of scoring shall be decided by the race committee and announced on the official notice board no later than 30 minutes before the starting signal for the first heat.
- (c) A board's heat standing shall be determined by adding together the points given by each judge. The board with the highest score wins and others shall be ranked accordingly.
- (d) Both semi-final heats shall have been sailed for an elimination series to be valid.
- (e) Except for members of the race committee responsible for scoring the event, only competitors in the heat shall be allowed to see judges' score sheets for the heat. Each score sheet shall bear the full name of the judge.
- (f) Scoring decisions of the judges shall not be grounds for a request for redress by a board.

A2 [B11.A2] SERIES TIES

- (a) In a heat, if there is a tie in the total points given by one or more judges, it shall be broken in favour of the board with the higher single score in the priority category. If the categories are weighted equally, in wave performance competition the tie shall be broken in favour of the board with the higher single score in wave riding, and in freestyle competition in favour of the board with the higher score for overall impression. If a tie remains, in wave performance competition it shall be broken in favour of the board with the

higher single score in the category without priority, and in freestyle competition it shall stand as the final result.

- (b) If there is a tie in the series score, it shall be broken in favour of the board that scored better more times than the other board. All scores shall be used even if some of them are excluded scores.
- (c) If a tie still remains, the heat shall be resailed. If this is not possible, the tie shall stand as the final result.

APPENDIX A – SCORING IN SPEED EVENTS

The rules of Appendix A are deleted and replaced by:

A1 [B12.A1] SPEED COMPETITON SCORING

- (a) On Standard Offshore Speed Courses, the speeds of a board's fastest two runs in a round shall be averaged to determine her standing in that round. The board with the highest average wins and others shall be ranked accordingly. If boards are tied, the tie shall be broken in favour of the board with the fastest run in the round.
- (b) On Speed Crossings and Alpha Speed Courses, boards shall be ranked based on their fastest run in the round.
- (c) If there is a series-score tie between two or more boards, it shall be broken in favour of the board(s) with the fastest run during the competition. If a tie remains, it shall be broken by applying rules B8.A8.2 and B8.A8.3.

A11 SCORING ABBREVIATIONS

These scoring abbreviations shall be used for recording the circumstances described:

DNC	Did not <i>start</i> ; did not come to the starting area
DNS	Did not <i>start</i> (other than DNC and OCS)
OCS	Did not <i>start</i> ; on the course side of the starting line at her starting signal and failed to <i>start</i> , or broke rule 30.1
ZFP	20% penalty under rule 30.2
UFD	Disqualification under rule 30.3
BFD	Disqualification under rule 30.4
SCP	Scoring Penalty applied
DNF	Did not <i>finish</i>
RET	Retired
DSQ	Disqualification
DNE	Disqualification that is not excludable
RDG	Redress given
DPI	Discretionary penalty imposed

APPENDIX D

TEAM RACING RULES

Team races shall be sailed under The Windsurfing Competition as changed by this appendix. If there is a conflict between rule in Appendix B and Appendix D, the rule in Appendix B shall prevail.

The sailing instructions may change any rule in Appendix D.

D1 CHANGES TO THE RACING RULES

D1.1 Definitions and the Rules of Parts 2 and 4

- (a) Deleted.
- (b) **[B2.18.2(b)]** If boards are *overlapped* when the first of them is *about to round or pass the mark*, the outside board at that moment shall thereafter give the inside board *mark-room*. If a board is *clear ahead* when she is *about to round or pass the mark*, or she later becomes *clear ahead* when another board passes head to wind, the board *clear astern* at that moment shall thereafter give her *mark-room*.
- (c) Rule 18.4 is deleted.
- (d) When rule 20 applies the following arm signals by the competitors are required in addition to the hails:
 - (1) for ‘Room to tack’, repeatedly and clearly pointing to windward; and
 - (2) for ‘You tack’, repeatedly and clearly pointing at the other board and waving the arm to windward.Sailing instructions may delete this requirement.
- (e) Change rule 24.1: If reasonably possible, a board not *racing* shall not interfere with a board that is *racing*, and a board that has *finished* shall not act to interfere with a board that has not *finished*.
- (f) Add new rule 24.4: ‘When boards in different races meet, any change of course by either board shall be consistent with complying with a *rule* or trying to win her own race.’
- (g) Add to rule 41:
 - (e) help from another board on her team provided electronic communication is not used.
- (h) Rule 45 is deleted.

D1.2 Protests and Requests for Redress

- (a) **[B5.60.1]** Rule 60.1 is changed to:
- A board may
- (1) protest another board, but not for an alleged breach of a rule of Part 2 unless she was involved in the incident or the incident involved contact between members of the other team; or
 - (2) request redress.
- (b) **[B5.61]** A board intending to protest shall inform the other board at the first reasonable opportunity. When her *protest* will concern an incident in the racing area that she was involved in, she shall hail 'Protest'. She shall also inform the race committee or the umpires of her intention to protest as soon as practicable after she *finishes* or retires.
- (c) A board intending to request redress for an incident in the racing area shall inform the race committee or the umpires of her intention to request redress as soon as practicable after she *finishes* or retires.
- (d) The race committee or protest committee shall not protest a board for breaking a rule of Part 2 except
- (1) based on evidence in a report from an umpire after a black and white flag has been displayed; or
 - (2) under rule 14 upon receipt of a report from any source alleging capsize, damage or injury.
- (e) *Protests* and requests for redress need not be in writing. The protest committee may take evidence in any way it considers appropriate and may communicate its decision orally.
- (f) A board is not entitled to redress based on capsize, damage or injury caused by another board on her team.
- (g) When a supplied board suffers a breakdown, rule D5 applies.

D1.3 Penalties

- (a) A board may take a 360°-Turn Penalty when she may have broken one of more rules of Part 2 in an incident while *racing*.
- (b) A board may take a penalty by retiring, in which case she shall notify the race committee as soon as possible and 6 points shall be added to her score.
- (c) There shall be no penalty for breaking a rule of Part 2 when the incident is between boards on the same team and there is no contact.

D2 UMPIRED RACES

D2.1 When Rule D2 Applies

Rule D2 applies to umpired races. Races to be umpired shall be identified either in the sailing instructions or by the display of flag J no later than the warning signal.

D2.2 Protests by Boards

When a board protests under a rule of Part 2 for an incident in the racing area, she is not entitled to a hearing, except under rule 14 when there is capsize, damage or injury, and the following applies:

- (a) She shall hail 'Protest'.
- (b) The boards shall be given time to respond. A board involved in the incident may respond by promptly taking an appropriate penalty or clearly indicating that she will do so as soon as possible.
- (c) If no board takes a penalty, an umpire shall decide whether to penalize any board.
- (d) If more than one board broke a rule and was not exonerated, an umpire may penalize any board that broke a rule and did not take an appropriate penalty.
- (e) An umpire shall signal a decision in compliance with rule D2.4.
- (f) A board penalized by an umpire shall take a Two 360°-Turn Penalty.

D2.3 Penalties Initiated by an Umpire

An umpire may penalize a board without a *protest* by another board, or report the incident to the protest committee, or both, when the board

- (a) breaks rule 31 or 42 and does not take a penalty;
- (b) breaks a rule of Part 2 and makes contact with another board on her team or with a board in another race, and no board takes a penalty;
- (c) breaks a *rule* and her team gains an advantage despite her, or another board on her team, taking a penalty;
- (d) breaks rule 14 and there is capsize, damage or injury;
- (e) clearly indicates that she will take a 360°-Turn Penalty, and then fails to do so;
- (f) fails to take a penalty signaled by an umpire;
- (g) commits a breach of sportsmanship.

The umpire shall signal a decision in compliance with rule D2.4. A board penalized by an umpire shall take a Two 360°-Turn Penalty except that, when an umpire hails a number of turns, the board shall take that

number of One 360°-Turn Penalties. All the penalty turns shall be performed in the same direction and in the same way.

D2.4 Signals by an Umpire

An umpire shall signal a decision with one long sound and the display of a flag as follows:

- (a) For no penalty, a green and white flag.
- (b) To penalize one or more boards, a red flag. The umpire shall hail or signal to identify each board penalized.
- (c) To report the incident to the protest committee, a black and white flag.

D2.5 Two-Flag Protest Procedure

This rule applies only if the sailing instructions so state and it then replaces rule D2.2.

D2.6 Limited Umpiring

This rule applies only if the sailing instructions so state and it then changes rules D2.2 and D2.5.

D2.7 Limitations on Other Proceedings

A decision, action or non-action of an umpire shall not be

- (a) grounds for redress,
- (b) subject to an appeal under rule 70, or
- (c) grounds for *abandoning* a race after it has started.

The protest committee may decide to consider giving redress when it believes that an official boat, including an umpire boat, may have seriously interfered with a competing board.

D3 SCORING A RACE

- D3.1**
- (a) Each board *finishing* a race shall be scored points equal to her finishing place. All other boards shall be scored points equal to the number of boards entitled to *race*.
 - (b) When a board is scored OCS, 10 points shall be added to her score unless she retired as soon as possible after the starting signal.
 - (c) When a board fails to take a penalty imposed by an umpire at or near the finishing line, she shall be scored points for last place and other scores shall be adjusted accordingly.
 - (d) When a protest committee decides that a board that is a *party* to a protest hearing has broken a *rule* and is not exonerated,
 - (1) if the board has not taken a penalty, 6 points shall be added to her score;

- (2) if the board's team has gained an advantage despite any penalty taken or imposed, the board's score may be increased;
- (3) when the board has broken rule 1 or 2, rule 14 when she has caused damage or injury, or a *rule* when not *racing*, half or more race wins may be deducted from her team, or no penalty may be imposed. Race wins deducted shall not be awarded to any other team.

D3.2 When all boards on one team have *finished*, retired or failed to *start*, the other team's boards *racing* at that time shall be scored the points they would have received had they *finished*.

D3.3 The team with the lower total points wins the race. If the totals are equal, the team that does not have first place wins.

D4 SCORING A STAGE

D4.1 Terminology

- (a) The racing format at an event will consist of one or more stages.
- (b) In a round-robin stage teams are assigned to one or more groups and scheduled to sail one or more round-robins. A round robin is a schedule of races in which each team sails once against each other team in the same group.
- (c) In a knock-out stage teams are scheduled to sail in matches. A match is one or more races between two teams.
- (d) The notice of race or sailing instructions may specify other formats and scoring methods.

D4.2 Terminating a Stage

- (a) The race committee may terminate a stage at any reasonable time taking into account the entries, weather, time constraints and other relevant factors.
- (b) When a round-robin stage is terminated, any round-robin in the stage in which 80% or more of the full schedule of races has been completed shall be scored as complete; if fewer races have been completed, the round-robin shall not be scored, but may be used to break ties.

D4.3 Scoring a Round-Robin Stage

- (a) In a round-robin stage the teams shall be ranked in order of number of race wins, highest number first. If the teams have not completed an equal number of races, they shall be ranked in order of the percentage of races won, highest number first.

- (b) If a round-robin in the stage is not completed, teams shall be ranked according to the results from all completed round-robins in the stage.

D4.4 Ties in a Completed Round-Robin Stage

Ties in a completed round-robin stage shall be broken by using, in the following order, only results in the stage,

- (a) the highest number of race wins in all races between the tied teams;
- (b) the lowest total points scored in all races between the tied teams;
- (c) if two teams remain tied, the winner of the last race between them;
- (d) the lowest average points scored in all races against common opponents;
- (e) a sail-off if possible, otherwise a game of chance.

If a tie is partially broken by one of these, the remaining tie shall be broken by starting again at rule D4.4(a).

D4.5 Ties in an Incomplete Round-Robin Stage

Ties in an incomplete round-robin stage shall be broken whenever possible using the results from races between the tied teams in any incomplete round-robin. Other ties shall be broken in accordance with rule D4.4.

D4.6 Scoring a Knock-Out Stage

The winner of a match is the first team to score the number of race wins stated in the sailing instructions.

D4.7 Incomplete Knock-Out Stage

If a match in a knock-out stage is not completed (including 0-0), the result of the match shall be determined using, in order,

- (a) the higher number of race wins in the incomplete match;
- (b) the higher number of race wins in all races in the event between the tied teams;
- (c) the higher place in the most recent stage, applying rule D4.4(a) if necessary;
- (d) the winner of the most recent race between the teams.

If this rule fails to determine a result, the stage shall be tied unless the sailing instructions provide for some other result.

D5 BREAKDOWNS WHEN BOARDS ARE SUPPLIED BY THE ORGANIZING AUTHORITY

- D5.1** Rule D5 applies when boards are supplied by the organizing authority.
- D5.2** When a board suffers a breakdown in the racing area, she may request a score change by displaying a red flag at the first reasonable opportunity after the breakdown until it is acknowledged by the race committee or by an umpire. If possible, she shall continue *racing*.
- D5.3** The race committee shall decide requests for a score change in accordance with rules D5.4 and D5.5. It may take evidence in any way it considers appropriate and may communicate its decision orally.
- D5.4** When the race committee decides that the team's finishing position was made significantly worse, that the breakdown was through no fault of the crew, and that in the same circumstances a reasonably competent crew would not have been able to avoid the breakdown, it shall make as equitable a decision as possible. This may be to *abandon* and resail the race or, when the board's finishing position was predictable, award her points for that position. Any doubt about a board's position when she broke down shall be resolved against her.
- D5.5** A breakdown caused by defective supplied equipment or a breach of a *rule* by an opponent shall not normally be determined to be the fault of the crew, but one caused by careless handling, capsizing or a breach by a board on the same team shall be. If there is doubt, it shall be presumed that the crew are not at fault.

APPENDIX G

IDENTIFICATION ON SAILS

See rule 77.

G1 WORLD SAILING CLASS BOATS

G1.1 Identification

Every board of a World Sailing Class shall carry on her sail

- (a) the insignia denoting her class;
- (b) at all international events, except when the boards are provided to all competitors, national letters denoting her national authority from the table below. For the purposes of this rule, international events are World Sailing events, world and continental championships, and events described as international events in their notices of race and sailing instructions; and
- (c) a sail number of no more than four digits allotted by her national authority or, when so required by the class rules, by the class association. The four-digit limitation does not apply to classes whose World Sailing membership or recognition took effect before 1 April 1997. Alternatively, if permitted in the class rules, an owner may be allotted a personal sail number by the relevant issuing authority, which may be used on all his boards in that class.

Sails measured before 31 March 1999 shall comply with rule G1.1 or with the rules applicable at the time of measurement.

Note: An up-to-date version of the table below is available on the World Sailing website.

NATIONAL SAIL LETTERS

<i>National authority</i>	<i>Letters</i>	<i>National authority</i>	<i>Letters</i>
Algeria	ALG	Ecuador	ECU
American Samoa	ASA	Egypt	EGY
Andorra	AND	El Salvador	ESA
Angola	ANG	Estonia	EST
Antigua	ANT	Fiji	FIJ
Argentina	ARG	Finland	FIN
Armenia	ARM	France	FRA
Aruba	ARU	Georgia	GEO
Australia	AUS	Germany	GER
Austria	AUT	Great Britain	GBR
Azerbaijan	AZE	Greece	GRE
Bahamas	BAH	Grenada	GRN
Bahrain	BRN	Guam	GUM
Barbados	BAR	Guatemala	GUA
Belarus	BLR	Hong Kong	HKG
Belgium	BEL	Hungary	HUN
Belize	BIZ	Iceland	ISL
Bermuda	BER	India	IND
Brazil	BRA	Indonesia	INA
British Virgin Islands	IVB	Iraq	IRQ
Brunei Darussalam	BRU	Ireland	IRL
Bulgaria	BUL	Israel	ISR
Canada	CAN	Italy	ITA
Cayman Islands	CAY	Jamaica	JAM
Chile	CHI	Japan	JPN
China, PR	CHN	Kazakhstan	KAZ
Chinese Taipei	TPE	Kenya	KEN
Colombia	COL	Korea, DPR	PRK
Cook Islands	COK	Korea, Republic of	KOR
Croatia	CRO	Kosovo	KOS
Cuba	CUB	Kuwait	KUW
Cyprus	CYP	Kyrgyzstan	KGZ
Czech Republic	CZE	Latvia	LAT
Denmark	DEN	Lebanon	LIB
Djibouti	DJI	Libya	LBA
Dominican Republic	DOM	Liechtenstein	LIE

<i>National authority</i>	<i>Letters</i>	<i>National authority</i>	<i>Letters</i>
Lithuania	LTU	Samoa	SAM
Luxembourg	LUX	San Marino	SMR
Macedonia (FYRO)	MKD	Saudi Arabia	KSA
Madagascar	MAD	Senegal	SEN
Malaysia	MAS	Serbia	SRB
Malta	MLT	Seychelles	SEY
Mauritius	MRI	Singapore	SIN
Mexico	MEX	Slovak Republic	SVK
Moldova	MDA	Slovenia	SLO
Monaco	MON	South Africa	RSA
Montenegro	MNE	Spain	ESP
Morocco	MAR	Sri Lanka	SRI
Mozambique	MOZ	St Lucia	LCA
Myanmar	MYA	St Vincent & Grenadines	VIN
Namibia	NAM	Sudan	SUD
Netherlands	NED	Sweden	SWE
Netherlands Antilles	AHO	Switzerland	SUI
New Zealand	NZL	Tahiti	TAH
Nicaragua	NCA	Tanzania	TAN
Nigeria	NGR	Thailand	THA
Norway	NOR	Timore Leste	TLS
Oman	OMA	Trinidad & Tobago	TTO
Pakistan	PAK	Tunisia	TUN
Palestine	PLE	Turkey	TUR
Panama	PAN	Uganda	UGA
Papua New Guinea	PNG	Ukraine	UKR
Paraguay	PAR	United Arab Emirates	UAE
Peru	PER	United States of America	USA
Philippines	PHI	Uruguay	URU
Poland	POL	US Virgin Islands	ISV
Portugal	POR	Vanuatu	VAN
Puerto Rico	PUR	Venezuela	VEN
Qatar	QAT	Vietnam	VIE
Romania	ROU	Zimbabwe	ZIM
Russia	RUS		

G1.2 Specifications

- (a) National letters and sail numbers shall be in capital letters and Arabic numerals, clearly legible and of the same colour. Commercially available typefaces giving the same or better legibility than Helvetica are acceptable.
- (b) The height of characters and space between adjoining characters on the same and opposite sides of the sail shall be related to the board's overall length as follows:

<i>Overall length</i>	<i>Minimum height</i>	<i>Minimum space between characters and from edge of sail</i>
Under 3.5 m	230 mm	45 mm
3.5 m – 8.5 m	300 mm	60 mm
8.5 m – 11 m	375 mm	75 mm
Over 11 m	450 mm	90 mm

G1.3 [B9.G1.3] Positioning

Class insignia, national letters and sail numbers shall be positioned as follows:

- (a) The class insignia shall be displayed once on each side of the sail in the area above a line projected at right angles from a point on the luff of the sail one-third of the distance from the head to the wishbone. The national letters and sail numbers shall be in the central third of that part of the sail above the wishbone, clearly separated from any advertising. They shall be black and applied back to back on an opaque white background. The background shall extend a minimum of 30 mm beyond the characters. There shall be a '–' between the national letters and the sail number, and the spacing between characters shall be adequate for legibility.
- (b) If the class insignia is of such a design that two of them coincide when placed back to back on both sides of the sail, they may be

G2 OTHER BOARDS

Other boards shall comply with the rules of their national authority or class association in regard to the allotment, carrying and size of insignia, letters and numbers. Such rules shall, when practicable, conform to the above requirements.

G3 CHARTERED OR LOANED BOARDS

When so stated in the notice of race or sailing instructions, a board chartered or loaned for an event may carry national letters or a sail number in contravention of her class rules.

G4 WARNINGS AND PENALTIES

When a protest committee finds that a board has broken a rule of this appendix, it shall either warn her and give her time to comply or penalize her.

G5 CHANGES BY CLASS RULES

World Sailing Classes may change the rules of this appendix provided the changes have first been approved by World Sailing.

APPENDIX H

WEIGHING CLOTHING AND EQUIPMENT

See rule 43. This appendix shall not be changed by sailing instructions or prescriptions of national authorities.

H1 Items of clothing and equipment to be weighed shall be arranged on a rack. After being saturated in water the items shall be allowed to drain freely for one minute before being weighed. The rack must allow the items to hang as they would hang from clothes hangers, so as to allow the water to drain freely. Pockets that have drain-holes that cannot be closed shall be empty, but pockets or items that can hold water shall be full.

H2 When the weight recorded exceeds the amount permitted, the competitor may rearrange the items on the rack and the member of the technical committee in charge shall again soak and weigh them. This procedure may be repeated a second time if the weight still exceeds the amount permitted.

H3 A competitor wearing a dry suit may choose an alternative means of weighing the items.

- (a) The dry suit and items of clothing and equipment that are worn outside the dry suit shall be weighed as described above.
- (b) Clothing worn underneath the dry suit shall be weighed as worn while *racing*, without draining.
- (c) The two weights shall be added together.

APPENDIX J

NOTICE OF RACE AND SAILING INSTRUCTIONS

See rules 89.2 and 90.2. In this appendix, the term 'race' includes a regatta or other series of races.

Care should be taken to ensure that there is no conflict between a rule in the notice of race and a rule in the sailing instructions.

J1 NOTICE OF RACE CONTENTS

J1.1 The notice of race shall include the following information:

- (1) the title, place and dates of the race and name of the organizing authority;
- (2) that the race will be governed by the *rules* as defined in *The Racing Rules of Sailing* or, equivalently under *The Windsurfing Competition Rules (WCR)*;
- (3) a list of any other documents that will govern the event (for example, *The Equipment Rules of Sailing*, to the extent that they apply), stating where or how each document or a copy of it may be seen;
- (4) the classes to race, any handicap or rating system that will be used and the classes to which it will apply, conditions of entry and any restrictions on entries;
- (5) the times of registration and warning signals for the practice race, if one is scheduled, and the first race, and succeeding races if known.

J1.2 The notice of race shall include any of the following that will apply and that would help competitors decide whether to attend the event or that conveys other information they will need before the sailing instructions become available:

- (1) changes to the racing rules permitted by rule 86, referring specifically to each rule and stating the change (also, if rule 86.2 applies, include the statement from World Sailing authorizing the change);
- (2) that boards will be required to display advertising chosen and supplied by the organizing authority (see rule 80 and World Sailing Regulation 20, Advertising Code) and other information related to Regulation 20;

- (3) any classification requirements that some or all competitors must satisfy (see rule 79 and World Sailing Regulation 22, Sailor Classification Code);
- (4) for an event where entries from other countries are expected, any national prescriptions that may require advance preparation (see rule 88);
- (5) the procedures for registration or entry, including fees and any closing dates;
- (6) an entry form, to be signed by the board's owner or owner's representative, containing words such as 'I agree to be bound by *The Racing Rules of Sailing* and by all other *rules* that govern this event.';
- (7) times or procedures for equipment inspection or event measurement, or requirements for measurement or rating certificates;
- (8) the time and place at which the sailing instructions will be available;
- (9) changes to class rules, as permitted under rule 87, referring specifically to each rule and stating the change;
- (10) the courses to be sailed;
- (11) the time after which no warning signal will be made on the last scheduled day of racing;
- (12) the penalty for breaking a rule of Part 2, other than the 360°-Turn Penalty;
- (13) denial of the right of appeal, subject to rule 70.5;
- (14) the scoring system, if different from the Low Point System in Appendix A, included by reference to class rules or other *rules* governing the event. State the number of races scheduled and the minimum number that must be completed to constitute a series;
- (15) for chartered or loaned boards, whether rule G3 applies;
- (16) prizes.

J2 SAILING INSTRUCTION CONTENTS

J2.1 The sailing instructions shall include the following information:

- (1) that the race will be governed by the *rules* as defined in *The Racing Rules of Sailing* or, equivalently under *The Windsurfing Competition Rules*;

- (2) a list of any other documents that will govern the event (for example, *The Equipment Rules of Sailing*, to the extent that they apply);
- (3) the schedule of races, the classes to race and times of warning signals for each class;
- (4) the course(s) to be sailed, or a list of *marks* from which the course will be selected and, if relevant, how courses will be signalled;
- (5) descriptions of *marks*, including starting and finishing *marks*, stating the order in which *marks* are to be passed and the side on which each is to be left and identifying all rounding *marks* (see rule 28.2);
- (6) descriptions of the starting and finishing lines, class flags and any special signals to be used;
- (7) the time limit, if any, for *finishing*;
- (8) the handicap or rating system to be used, if any, and the classes to which it will apply;
- (9) unless stated in the notice of race, the scoring system, if different from the Low Point System in Appendix A, included by reference to class rules or other *rules* governing the event, or stated in full. State the number of races scheduled and the minimum number that must be completed to constitute a series;
- (10) unless stated in the notice of race, location(s) of official notice board(s) or address of online notice board.

J2.2 The sailing instructions shall include those of the following that will apply:

- (1) that boards will be required to display advertising chosen and supplied by the organizing authority (see rule 80 and World Sailing Regulation 20, Advertising Code) and other information related to Regulation 20;
- (2) replacement of the rules of Part 2 with the right-of-way rules of the *International Regulations for Preventing Collisions at Sea* or other government right-of-way rules, the time(s) or place(s) they will apply, and any night signals to be used by the race committee;
- (3) changes to the racing rules permitted by rule 86, referring specifically to each rule and stating the change (also, if rule 86.2 applies, include the statement from World Sailing authorizing the change);
- (4) changes to the national prescriptions (see rule 88.2);

- (5) prescriptions that will apply if boards will pass through the waters of more than one national authority while *racing*, and when they will apply (see rule 88.1);
- (6) when appropriate, at an event where entries from other countries are expected, a copy in English of the national prescriptions that will apply;
- (7) changes to class rules, as permitted under rule 87, referring specifically to each rule and stating the change;
- (8) restrictions controlling changes to boards when supplied by the organizing authority;
- (9) unless included in the notice of race, times or procedures for equipment inspection or event measurement;
- (10) procedure for changing the sailing instructions;
- (11) procedure for giving oral changes to the sailing instructions on the water (see rule 90.2(c));
- (12) safety requirements, such as requirements and signals for personal flotation devices, check-in at the starting area, and check-out and check-in ashore;
- (13) declaration requirements;
- (14) signals to be made ashore and location of signal station(s);
- (15) the racing area (a chart is recommended);
- (16) approximate course length and approximate length of windward legs;
- (17) description of any area designated by the race committee to be an *obstruction* (see the definition *Obstruction*);
- (18) the time after which no warning signal will be made on the last scheduled day of racing;
- (19) the time limit, if any, for the first board to *finish* and the time limit, if any, for boards other than the first board to *finish*;
- (20) time allowances;
- (21) location of the starting area and any restrictions on entering it;
- (22) any special procedures or signals for individual or general recall;
- (23) boats identifying *mark* locations;
- (24) any special procedures or signals for changing a leg of the course (see rule 33);
- (25) any special procedures for shortening the course or for *finishing* a shortened course;

- (26) restrictions on use of support boats, plastic pools, radios, etc.; on trash disposal; on hauling out; and on outside assistance provided to a board that is not *racing*;
- (27) the penalty for breaking a rule of Part 2, other than the 360°-Turn Penalty;
- (28) and (29) deleted
- (30) time limits, place of hearings, and special procedures for *protests*, requests for redress or requests for reopening;
- (31) if rule N1.4(b) will apply, the time limit for requesting a hearing under that rule;
- (32) denial of the right of appeal, subject to rule 70.5;
- (33) when required by rule 70.3, the national authority to which appeals and requests may be sent;
- (34) the national authority's approval of the appointment of an international jury, when required under rule 91(b);
- (35) substitution of competitors;
- (36) the minimum number of boards appearing in the starting area required for a race to be started;
- (37) when and where races *postponed* or *abandoned* for the day will be sailed;
- (38) tides and currents;
- (39) prizes;
- (40) other commitments of the race committee and obligations of boards.

APPENDIX K

NOTICE OF RACE GUIDE

This guide provides a notice of race designed primarily for major championship regattas for one or more classes. It therefore will be particularly useful for world, continental and national championships and other events of similar importance. It can be downloaded from the World Sailing website as a basic text for producing a notice of race for any particular event.

The guide can also be useful for other events. However, for such events some of the paragraphs will be unnecessary or undesirable. Organizing authorities should therefore be careful in making their choices.

This guide relates closely to Appendix L, Sailing Instructions Guide, and its expanded version Appendix LE on the World Sailing website, the introduction to which contains principles that also apply to a notice of race.

Rule references within the notice of race use WCR, NoR and SI to denote the source of the rule. 'WCR x' is a rule in The Windsurfing Competition Rules. 'NoR x' is a rule in the notice of race, and 'SI x' is a rule in the sailing instructions.

To use this guide, first review rule J1 and decide which paragraphs will be needed. Paragraphs that are required by rule J1.1 are marked with an asterisk (). Delete all inapplicable or unnecessary paragraphs. Select the version preferred where there is a choice. Follow the directions in the left margin to fill in the spaces where a solid line (_____) appears and select the preferred wording if a choice or option is shown in brackets ([. . .]).*

After deleting unused paragraphs, renumber all paragraphs in sequential order. Be sure that paragraph numbers are correct where one paragraph refers to another.

Care should be taken to ensure that there is no conflict between a rule in the notice of race and a rule in the sailing instructions.

If the notice of race is made available electronically, printed copies should be provided on request.

The items listed below, when applicable, should be distributed with the notice of race, but should not be included as numbered paragraphs in the notice.

- 1 *An entry form, to be signed by the board's owner or owner's representative, containing words such as 'I agree to be bound by The Racing Rules of Sailing or equivalently under The Windsurfing Competition Rules and by all other rules that govern this event.'*
- 2 *For an event where entries from other countries are expected, the applicable national prescriptions in English.*
- 3 *List of sponsors, if appropriate.*
- 4 *Lodging and camping information.*
- 5 *Description of meal facilities.*
- 6 *Race committee and protest committee members.*
- 7 *Special mooring or storage requirements.*
- 8 *Sail and board repair facilities and ship's chandlers.*
- 9 *Availability of chartered or loaned boards and whether rule G3 will apply.*

On separate lines, insert the full name of the regatta, the inclusive dates from equipment inspection, event measurement or the practice race until the final race or closing ceremony, the name of the organizing authority, and the city and country.

NOTICE OF RACE

The notation '[DP]' in a rule in the NoR means that the penalty for a breach of that rule may, at the discretion of the protest committee, be less than disqualification.

1 RULES

- 1.1*** *The regatta will be governed by the rules as defined in *The Racing Rules of Sailing* or, equivalently under *The Windsurfing Competition Rules*.*

Use the first sentence if appropriate. Insert the name. List by number and title the prescriptions that will not apply (see WCR 88). Use the second sentence if it applies and if entries from other countries are expected, and state the relevant prescriptions in full.

- 1.2** [The following prescriptions of the _____ national authority will not apply: _____.]
[The prescriptions that may require advance preparation are stated in full below.]

(OR)

Use if appropriate, but only if the national authority for the venue of the event has not adopted a prescription to WCR 88.

- 1.2** No national prescriptions will apply.

List by name any other documents that govern the event; for example, The Equipment Rules of Sailing, to the extent that they apply.

- 1.3*** _____ will apply.

See WCR 86. Insert the rule number(s) and summarize the changes.

- 1.4** Racing rule(s) _____ will be changed as follows: _____. The changes will appear in full in the sailing instructions. The sailing instructions may also change other racing rules.

(OR)

See WCR 86. Either insert here the rule number(s) and state the changes, or, if not using this NoR, do the same in each NoR that changes a racing rule.

- 1.4** Racing rule(s) _____ will be changed as follows: _____.

Insert the rule number(s) and class name. Make a separate statement for the rules of each class.

- 1.5** Under RRS 87, rule(s) _____ of the _____ class rules [will not apply] [is (are) changed as follows: _____].

- 1.6** If there is a conflict between languages the English text will take precedence.

Use only if RRS Appendix S, Standard Sailing Instructions, will be used.

1.7 The sailing instructions will consist of the instructions in RRS Appendix S, Standard Sailing Instructions, and supplementary sailing instructions that will be on the official notice board located at _____.

Insert the location.

2 ADVERTISING

See World Sailing Regulation 20, Advertising Code. Include other applicable information related to Regulation 20.

2.1 Competitor advertising will be restricted as follows: _____.

See World Sailing Regulation 20.4.

2.2 Boards [shall] [may] be required to display advertising chosen and supplied by the organizing authority. If this rule is broken, World Sailing Regulation 20.9.2 applies. [DP]

3* ELIGIBILITY AND ENTRY

Insert the class(es).

3.1 The regatta is open to all boards of the _____ class(es).

(OR)

Insert the class(es) and eligibility requirements.

3.1 The regatta is open to boards of the _____ class(es) that _____.

Insert the postal, fax and email addresses and entry closing date.

3.2 Eligible boards may enter by completing the attached form and sending it, together with the required fee, to _____ by _____.

Insert any conditions.

3.3 Late entries will be accepted under the following conditions: _____.

Insert any restrictions.

3.4 The following restrictions on the number of boards apply: _____.

4 CLASSIFICATION

Insert any requirements.

The following classification requirements will apply (see RRS 79): _____.

5 FEES

Insert all required fees for racing.

5.1 Required fees are as follows:

<i>Class</i>	<i>Fee</i>
_____	_____
_____	_____
_____	_____

Insert optional fees (for example, for social events).

5.2 Other fees:

6 QUALIFYING SERIES AND FINAL SERIES

Use only when a class is divided into fleets racing a qualifying series and a final series.

The regatta will consist of a qualifying series and a final series.

7 SCHEDULE

Insert the day, date and times.

7.1* Registration:

Day and date _____
From _____ To _____

Insert the day, date and times.

7.2 Equipment inspection and event measurement:

Day and date _____
From _____ To _____

Revise as desired and insert the dates and classes. Include a practice race if any. When the series consists of qualifying races and final races, specify them. The schedule can also be given in an attachment.

7.3* Dates of racing:

<i>Date</i>	<i>Class</i> _____	<i>Class</i> _____
_____	racing	racing
_____	racing	reserve day
_____	reserve day	racing
_____	racing	racing
_____	racing	racing

Insert the classes and numbers.

7.4	Number of races:		
	<i>Class</i>	<i>Numbe</i>	<i>Races per day</i>
	_____	_____	_____
	_____	_____	_____

Insert the time.

7.5* The scheduled time of the warning signal for the [practice race] [first race] [each day] is _____.

Use when it would be helpful to competitors to know this time before the event. Insert the time.

7.6 On the last scheduled day of racing no warning signal will be made after _____.

8 MEASUREMENT

8.1 Each board shall produce a valid [measurement] [rating] certificate.

(OR)

List the equipment with appropriate references to the class rules.

8.1 Each board shall produce a valid [measurement] [rating] certificate. In addition, the following equipment [may] [will] be inspected or measured: _____.

Insert the time(s).

8.2 A board shall comply with WCR 78.1 at _____.

Insert the time, date and location.

9 SAILING INSTRUCTIONS
The sailing instructions will be available after _____ on _____ at _____.

10 VENUE

Insert a number or letter. Provide a marked map with driving instructions.

10.1 Attachment _____ shows the location of the regatta harbour.

Insert a number or letter. Provide a marked map or chart.

10.2 Attachment _____ shows the location of the racing areas.

11 THE COURSES

Include the description.

The courses to be sailed will be as follows:

_____.

(OR)

Insert a number or letter. A method of illustrating various courses is shown in Addendum A of Appendix L or LE. Insert the course length if applicable.

The diagrams in Attachment _____ show the courses, including the approximate angles between legs, the order in which marks are to be passed, and the side on which each mark is to be left. [The approximate course length will be _____.]

12 PENALTY SYSTEM

Include paragraph 12.1 only when the Two-Turns Penalty will not be used. Insert the number of places or describe the penalties.

12.1 The Scoring Penalty, RRS 44.3, will apply. The penalty will be _____ places.

(OR)

12.1 The penalties are as follows: _____.

Insert the class(es).

12.2 For the _____ class(es) RRS 44.1 is changed so that the 360°-Turn Penalty is replaced by the another Penalty.

Include only if the protest committee is an international jury or another provision of WCR 70.5 applies.

12.3 Decisions of the [protest committee] [international jury] will be final as provided in RRS 70.5.

13 SCORING

Include only if the Low Point System of Appendix A will not be used. Describe the system.

13.1 The scoring system is as follows: _____.

Include only if the Low Point System of Appendix A will not be used. Describe the system.

13.1 The scoring system is as follows: _____.

Insert the number.

13.2 _____ races are required to be completed to constitute a series.

Insert the numbers throughout.

- 13.3** (a) When fewer than _____ races have been completed, a board's series score will be the total of her race scores.
- (b) When from _____ to _____ races have been completed, a board's series score will be the total of her race scores excluding her worst score.
- (c) When _____ or more races have been completed, a board's series score will be the total of her race scores excluding her two worst scores.

Insert the identification markings. National letters are suggested for international events.

14 SUPPORT BOATS

Support boats shall be marked with _____. [DP]

15 BERTHING

Boards shall be kept in their assigned places while they are in the [board park] [harbour]. [DP]

16 HAUL-OUT RESTRICTIONS

Not applicable

17 DIVING EQUIPMENT AND PLASTIC POOLS

Not applicable

18 RADIO COMMUNICATION

Insert any alternative text that applies. Describe any radio communication bands or frequencies that will be used or allowed.

Except in an emergency, a board that is racing shall not make voice or data transmissions and shall not receive voice or data communication that is not available to all boards. [DP]

If perpetual trophies will be awarded state their complete names.

19 PRIZES

Prizes will be given as follows: _____.

20 DISCLAIMER OF LIABILITY

The laws applicable to the venue in which the event is held may limit disclaimers. Any disclaimer should be drafted to comply with those laws.

Competitors participate in the regatta entirely at their own risk. See WCR 4, Decision to Race. The organizing authority will not accept any liability for material damage or personal injury or death sustained in conjunction with or prior to, during, or after the regatta.

21 INSURANCE

Insert the currency and amount.

Each participating board shall be insured with valid third-party liability insurance with a minimum cover of _____ per incident or the equivalent.

22 FURTHER INFORMATION

Insert necessary contact information.

For further information please contact _____

APPENDIX L

SAILING INSTRUCTIONS GUIDE

This guide provides a set of tested sailing instructions designed primarily for major championship regattas for one or more classes. It therefore will be particularly useful for world, continental and national championships and other events of similar importance. The guide can also be useful for other events; however, for such events some of these instructions will be unnecessary or undesirable. Race officers should therefore be careful in making their choices.

An expanded version of the guide, Appendix LE, is available on the World Sailing website. It contains provisions applicable to the largest and most complicated multi-class events, as well as variations on several of the sailing instructions recommended in this appendix. It will be revised from time to time, to reflect advances in race management techniques as they develop, and can be downloaded as a basic text for producing the sailing instructions for any particular event. Appendix L can also be downloaded from the World Sailing website.

The principles on which all sailing instructions should be based are as follows:

- 1 They should include only two types of statement: the intentions of the race committee and protest committee and the obligations of competitors.*
- 2 They should be concerned only with racing. Information about social events, assignment of moorings, etc., should be provided separately.*
- 3 They should not change the racing rules except when clearly desirable. (When they do so, they must follow rule 86 by referring specifically to the rule being changed and stating the change.)*
- 4 They should not repeat or restate any of the racing rules.*
- 5 They should not repeat themselves.*
- 6 They should be in chronological order; that is, the order in which the competitor will use them.*
- 7 They should, when possible, use words or phrases from the racing rules.*

Rule references within the sailing instructions use WCR, SI and NoR to denote the source of the rule. 'WCR x' is a rule in The Windsurfing

Competition Rules. ‘SI x’ is a rule in the sailing instructions, and ‘NoR x’ is a rule in the notice of race.

To use this guide, first review rule J2 and decide which instructions will be needed. Instructions that are required by rule J2.1 are marked with an asterisk (). Delete all inapplicable or unnecessary instructions. Select the version preferred where there is a choice. Follow the directions in the left margin to fill in the spaces where a solid line (_____) appears and select the preferred wording if a choice or option is shown in brackets ([. . .]).*

After deleting unused instructions, renumber all instructions in sequential order. Be sure that instruction numbers are correct where one instruction refers to another.

Care should be taken to ensure that there is no conflict between a rule in the notice of race and a rule in the sailing instructions.

If the sailing instructions are made available electronically, printed copies should be provided on request.

On separate lines, insert the full name of the regatta, the inclusive dates from equipment inspection, event measurement or the practice race until the final race or closing ceremony, the name of the organizing authority, and the city and country.

SAILING INSTRUCTIONS

The notation ‘[DP]’ in a rule in the SI means that the penalty for a breach of that rule may, at the discretion of the protest committee, be less than disqualification.

1 RULES

- 1.1*** The regatta will be governed by the rules as defined in *The Racing Rules of Sailing* or, equivalently under *The Windsurfing Competition Rules*.

Use the first sentence if appropriate. Insert the name. List by number and title the prescriptions that will not apply (see RRS 88.2). Use the second sentence if it applies and if entries from other national authorities are expected, and state the prescriptions in full. Include the prescriptions in English when appropriate (see WCR 90.2(b)).

- 1.2** [The following prescriptions of the _____ national authority will not apply: _____.]
[The prescriptions that will apply are stated in full below.]

Use if appropriate, but only if the national authority for the venue of the event has not adopted a prescription to WCR 88.

- (OR)**
1.2 No national prescriptions will apply.

List by name any other documents that govern the event; for example, The Equipment Rules of Sailing, to the extent that they apply.

- 1.3*** _____ will apply.

See WCR 86. Either insert here the rule number(s) and state the changes, or, if not using this instruction, do the same in each instruction that changes a racing rule.

- 1.4** Racing rule(s) _____ will be changed as follows: _____.

Insert the rule number(s) and class name. Make a separate statement for the rules of each class.

- 1.5** Under WCR 87, rule(s) _____ of the _____ class rules [will not apply] [is (are) changed as follows: _____].

- 1.6** If there is a conflict between languages the English text will take precedence.

2* **NOTICES TO COMPETITORS**

Insert the location(s). If notices are online, state

Notices to competitors will be posted on the official notice board(s) located at

how and where they may be found.

_____.

3 CHANGES TO SAILING INSTRUCTIONS

Change the times if different.

Any change to the sailing instructions will be posted before 0900 on the day it will take effect, except that any change to the schedule of races will be posted by 2000 on the day before it will take effect.

4 SIGNALS MADE ASHORE

Insert the location.

4.1 Signals made ashore will be displayed at _____.

Insert the number of minutes.

4.2 When flag AP is displayed ashore, ‘1 minute’ is replaced with ‘not less than _____ minutes’ in the race signal AP.

(OR)

Insert the number of minutes.

4.2 Flag D with one sound means ‘The warning signal will be made not less than _____ minutes after flag D is displayed. [Boards are requested not to leave the harbour until this signal is made.] [Boards shall not leave the harbour until this signal is made. [DP]]’

5 SCHEDULE OF RACES

Revise as desired and insert the dates and classes. Include a practice race if any. When the series consists of qualifying races and final races, specify them. The schedule can also be given in an attachment.

5.1* Dates of racing:

<i>Date</i>	<i>Class</i> _____	<i>Class</i> _____
_____	racing	racing
_____	racing	reserve day
_____	reserve day	racing
_____	racing	racing
_____	racing	racing

5.2* Number of races:

Insert the classes and numbers.

<i>Class</i>	<i>Number</i>	<i>Races per day</i>
_____	_____	_____
_____	_____	_____

One extra race per day may be sailed, provided that no class becomes more than one race ahead of schedule and the change is made according to SI 3.

Insert the time.

5.3* The scheduled time of the warning signal for the first race each day is _____.

5.4 To alert boards that a race or sequence of races will begin soon, the orange starting line flag will be displayed with one sound at least five minutes before a warning signal is made.

Insert the time.

5.5 On the last scheduled day of racing no warning signal will be made after _____.

6* CLASS FLAGS

Class flags will be:

Insert the classes and names or descriptions of the flags.

<i>Class</i>	<i>Flag</i>
_____	_____
_____	_____
_____	_____

7 RACING AREAS

Insert a number or letter.

Attachment _____ shows the location of racing areas.

8 THE COURSES

Insert a number or letter. A method of illustrating various courses is shown in Addendum A. Insert the course length if applicable.

8.1* The diagrams in Attachment _____ show the courses, including the approximate angles between legs, the order in which marks are to be passed, and the side on which each mark is to be left. [The approximate course length will be _____.]

8.2 No later than the warning signal, the race committee signal vessel will display the approximate compass bearing of the first leg.

- 8.3** Courses will not be shortened. This changes RRS 32.
- Include only when changing positions of marks is impracticable.*
- 8.4** Legs of the course will not be changed after the preparatory signal. This changes WCR 33.
- 9 MARKS**
- Change the mark numbers as needed and insert the descriptions of the marks. Use the second alternative when Marks 4S and 4P form a gate, with Mark 4S to be left to starboard and Mark 4P to port.*
- 9.1*** Marks 1, 2, 3 and 4 will be _____.
- (OR)**
- 9.1*** Marks 1, 2, 3, 4S and 4P will be _____.
- (OR)**
- Insert the number or letter used in SI 8.1.*
- 9.1*** Marks are described in Attachment _____.
- Unless it is clear from the course diagrams, list the marks that are rounding marks.*
- 9.2** The following marks are rounding marks: _____.
- Insert the descriptions of the marks.*
- 9.3** New marks, as provided in SI 12.1, will be _____.
- Describe the starting and finishing marks: for example, the race committee signal vessel at the starboard end and a buoy at the port end. SI 11.2 will describe the starting line and SI 13 the finishing line.*
- 9.4*** The starting and finishing marks will be _____.
- Include if SI 12.2 is included.*
- 9.5** A race committee vessel signalling a change of a leg of the course is a mark as provided in SI 12.2.

- Describe each area by its location and any easily recognized details of appearance.*
- 10 AREAS THAT ARE OBSTRUCTIONS**
The following areas are designated as obstructions: _____.
- Include only if the asterisked option in RRS 26 will be used. Insert the number of minutes.*
- 11 THE START**
- 11.1** Races will be started by using WCR 26 with the warning signal made _____ minutes before the starting signal.
- (OR)**
- 11.1** Races will be started as follows: _____. This changes WCR 26.
- 11.2*** The starting line will be between staffs displaying orange flags on the starting marks.
- (OR)**
- 11.2*** The starting line will be between a staff displaying an orange flag on the starting mark at the starboard end and the course side of the port-end starting mark.
- (OR)**
- Insert the description.*
- 11.2*** The starting line will be _____.
- 11.3** Boards whose warning signal has not been made shall avoid the starting area during the starting sequence for other races. [DP]
- Insert the number of minutes.*
- 11.4** A board that does not start within _____ minutes after her starting signal will be scored Did Not Start without a hearing. This changes WCR A4 and A5.
- Insert the channel number.*
- 11.5** Not applicable
- 12 CHANGE OF THE NEXT LEG OF THE COURSE**
- 12.1** To change the next leg of the course, the race committee will move the original mark (or the finishing line) to a new position.

(OR)

12.1 To change the next leg of the course, the race committee will lay a new mark (or move the finishing line) and remove the original mark as soon as practicable. When in a subsequent change a new mark is replaced, it will be replaced by an original mark.

When SI 12.2 is included, SI 9.5 must also be included. Reverse 'port' and 'starboard' when the mark is to be left to starboard.

12.2 Except at a gate, boards shall pass between the race committee vessel signalling the change of the next leg and the nearby mark, leaving the mark to port and the race committee vessel to starboard. This changes RRS 28.

13 THE FINISH

13.1* The finishing line will be between staffs displaying orange flags on the finishing marks.

(OR)

13.1* The finishing line will be between a staff displaying an orange flag on the finishing mark at the starboard end and the course side of the port-end finishing mark.

(OR)

Insert the description.

13.1* The finishing line will be _____.

13.2 If the race committee is absent when a board finishes, she should report her finishing time, and her position in relation to nearby boards, to the race committee at the first reasonable opportunity.

14 PENALTY SYSTEM

Include SI 14.1 only when the Two-Turns Penalty will not be used. Insert the number of places or describe the penalties.

14.1 The Scoring Penalty, RRS 44.3, will apply. The penalty will be _____ places.

(OR)

14.1 The penalties are as follows: _____.

Insert the class(es). **14.2** For the _____ class(es) RRS 44.1 is changed so that the 360°-Turn Penalty is replaced by the another Penalty.

Unless all of Appendix P applies, state any restrictions. **14.3** Not applicable

Recommended only for junior events. **14.4** Not applicable

15 TIME LIMITS AND TARGET TIMES

Insert the classes and times. Omit the Mark 1 time limit and target time if inapplicable. **15.1*** Time limits and target times are as follows:

<i>Class</i>	<i>Time limit</i>	<i>Mark 1 time limit</i>	<i>Target time</i>
_____	_____	_____	_____
_____	_____	_____	_____
_____	_____	_____	_____

If no board has passed Mark 1 within the Mark 1 time limit the race will be abandoned. Failure to meet the target time will not be grounds for redress. This changes WCR 62.1(a).

Insert the time (or different times for different classes). **15.2** Boards failing to finish within _____ after the first boat sails the course and finishes will be scored Did Not Finish without a hearing. This changes WCR 35, A4 and A5.

16 PROTESTS AND REQUESTS FOR REDRESS

State the location if necessary. **16.1** Protest forms are available at the race office[, located at _____]. Protests and requests for redress or reopening shall be delivered there within the appropriate time limit.

Change the time if different. **16.2** For each class, the protest time limit is 90 minutes after the last board has finished the last race of the day or the race committee signals no more racing today, whichever is later.

- Change the posting time if different. Insert the protest room location and, if applicable, the time for the first hearing.*
- 16.3** Notices will be posted no later than 30 minutes after the protest time limit to inform competitors of hearings in which they are parties or named as witnesses. Hearings will be held in the protest room, located at _____, beginning at [the time posted] [_____].
- 16.4** Notices of protests by the race committee, technical committee or protest committee will be posted to inform boards under RRS 61.1(b).
- 16.5** Not applicable
- 16.6** Breaches of SIs 11.3, 18, 21, 23, 25, 26 and 27 will not be grounds for a protest by a board. This changes WCR 60.1(a).
- 16.7** On the last scheduled day of racing a request for redress based on a protest committee decision shall be delivered no later than 30 minutes after the decision was posted. This changes WCR 62.2.
- Include only if WCR 70.5 applies.*
- 16.8** Decisions of the [protest committee] [international jury] will be final as provided in WCR 70.5.
- 17 SCORING**
- Include only if the Low Point System of Appendix A will not be used. Describe the system.*
- 17.1** The scoring system is as follows: _____.
- Insert the number.*
- 17.2** _____ races are required to be completed to constitute a series.
- Insert the numbers throughout.*
- 17.3** (a) When fewer than _____ races have been completed, a board's series score will be the total of her race scores.
- (b) When from _____ to _____ races have been completed, a board's series score will be the total of her race scores excluding her worst score.

- (c) When _____ or more races have been completed, a board's series score will be the total of her race scores excluding her two worst scores.

18 SAFETY REGULATIONS

Insert the procedure for check-out and check-in.

- 18.1** Check-Out and Check-In: _____. [DP]

- 18.2** A board that retires from a race shall notify the race committee as soon as possible. [DP]

19 REPLACEMENT OF CREW OR EQUIPMENT

- 19.1** Substitution of competitors will not be allowed without prior written approval of the [race committee] [protest committee]. [DP]

- 19.2** Substitution of damaged or lost equipment will not be allowed unless authorized by the [race committee] [protest committee]. Requests for substitution shall be made to the committee at the first reasonable opportunity. [DP]

20 EQUIPMENT AND MEASUREMENT CHECKS

On the water, a board can be instructed by a member of the race committee or the technical committee to proceed immediately to a designated area for inspection. Ashore, equipment may be inspected or measured at times specified in the class rules, the notice of race, and at the following time(s) _____.

Insert the time(s).

21 EVENT ADVERTISING

See World Sailing Regulation 20.4. Insert necessary information on the display of event advertising material.

Boards shall display event advertising supplied by the organizing authority as follows: _____. If this rule is broken, World Sailing Regulation 20.9.2 applies. [DP]

- Insert the descriptions. If appropriate, use different identification markings for boats performing different duties.*
- 22 OFFICIAL BOATS**
 Official boats will be marked as follows: _____.
- 23 SUPPORT BOATS**
- 23.1** Team leaders, coaches and other support persons shall stay outside areas where boards are racing from the time of the preparatory signal for the first class to start until all boards have finished or retired or the race committee signals a postponement, general recall or abandonment. [DP]
- Insert the identification markings. National letters are suggested for international events.*
- 23.2** Support boats shall be marked with _____. [DP]
- 24 TRASH DISPOSAL**
 Trash may be placed aboard support or official boats.
- 25** Not applicable
- 26** Not applicable
- 27 RADIO COMMUNICATION**
 Except in an emergency, a board that is racing shall not make voice or data transmissions and shall not receive voice or data communication that is not available to all boards. [DP]
- Insert any alternative text that applies. Describe any radio communication bands or frequencies that will be used or allowed.*
- 28 PRIZES**
 Prizes will be given as follows: _____.
- If perpetual trophies will be awarded state their complete names.*

29 DISCLAIMER OF LIABILITY

The laws applicable to the venue in which the event is held may limit disclaimers. Any disclaimer should be drafted to comply with those laws.

Competitors participate in the regatta entirely at their own risk. See WCR 4, Decision to Race. The organizing authority will not accept any liability for material damage or personal injury or death sustained in conjunction with or prior to, during, or after the regatta.

30 INSURANCE

Insert the currency and amount.

Each participating board shall be insured with valid third-party liability insurance with a minimum cover of _____ per incident or the equivalent.

ADDENDUM A

ILLUSTRATING THE COURSE

Shown here are diagrams of course shapes. The board's track is represented by a discontinuous line so that each diagram can describe courses with different numbers of laps. If more than one course may be used for a class, state how each particular course will be signalled.

A Windward-Leeward Course

Start – 1 – 2 – 1 – 2 – Finish

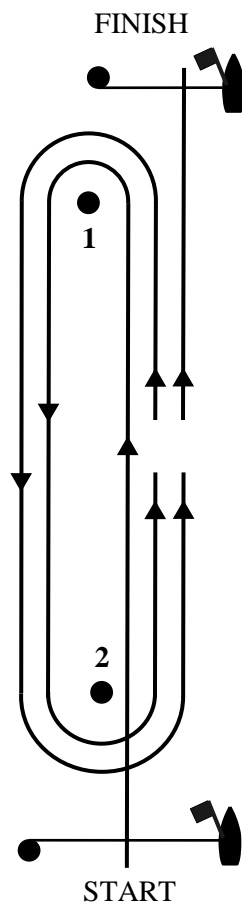

Options for this course include

- (1) increasing or decreasing the number of laps,*
- (2) deleting the last windward leg,*
- (3) using a gate instead of a leeward mark,*
- (4) using an offset mark at the windward mark, and*
- (5) using the leeward and windward marks as starting and finishing marks.*

A Triangle-Windward-Leeward Course

Start – 1 – 2 – 3 – 1 – 3 – Finish

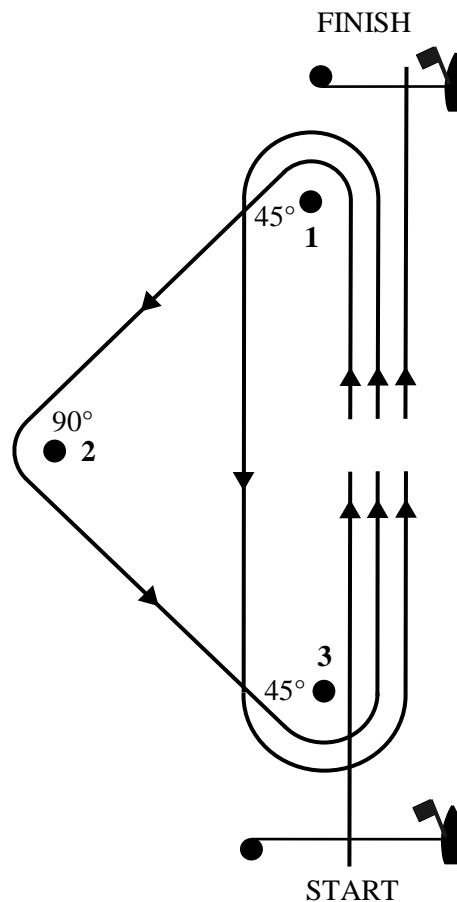

Options for this course include

- (1) *increasing or decreasing the number of laps,*
- (2) *deleting the last windward leg,*
- (3) *varying the interior angles of the triangle (45°–90°–45° and 60°–60°–60° are common),*
- (4) *using a gate instead of a leeward mark for downwind legs,*
- (5) *using an offset mark at the beginning of downwind legs, and*
- (6) *using the leeward and windward marks as starting and finishing marks.*

Be sure to specify the interior angle at each mark.

Trapezoid Courses

Start – 1 – 2 – 3 – 2 – 3 – Finish

Start – 1 – 4 – 1 – 2 – 3 – Finish

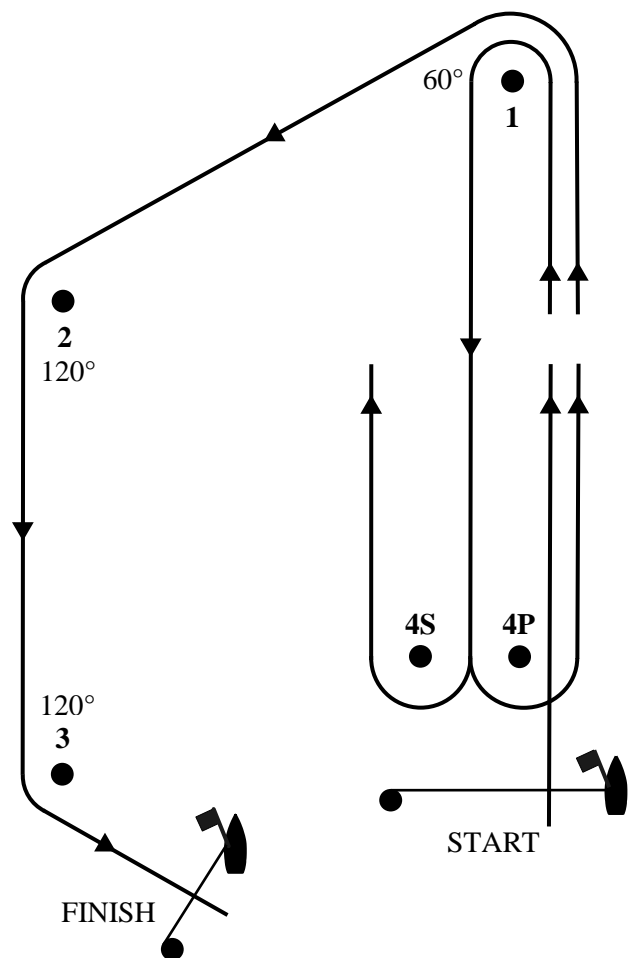
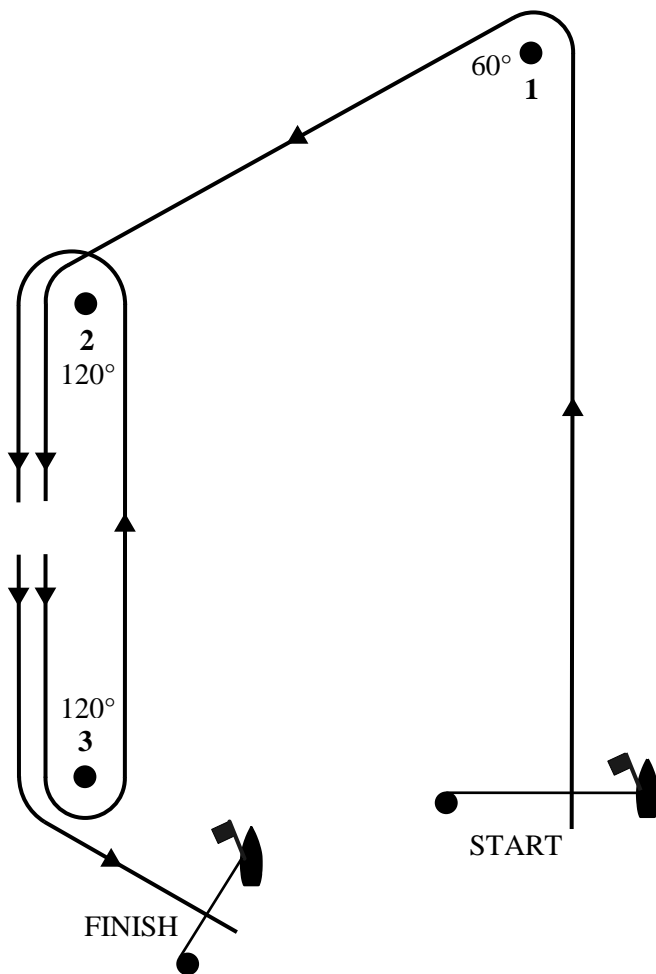

Options for these courses include

- (1) *adding additional legs,*
- (2) *replacing the gate shown by a single mark, or using a gate also in the outer loop,*
- (3) *varying the interior angles of the reaching legs,*
- (4) *using an offset mark at the beginning of downwind legs, and*
- (5) *finishing boats upwind rather than on a reach.*

Be sure to specify the interior angle of each reaching leg.

ADDENDUM B

BOARDS PROVIDED BY THE ORGANIZING AUTHORITY

The following sailing instruction is recommended when all boards will be provided by the organizing authority. It can be changed to suit the circumstances. When used, it should be inserted after SI 3.

4 BOARDS

- 4.1** Boards will be provided for all competitors, who shall not modify them or cause them to be modified in any way except that
- (a) a compass may be tied or taped to the hull or spars;
 - (b) wind indicators, including yarn or thread, may be tied or taped anywhere on the board;
 - (c) hulls and centreboard may be cleaned, but only with water;
 - (d) adhesive tape may be used anywhere above the water line; and
 - (e) all fittings or equipment designed to be adjusted may be adjusted, provided that the class rules are complied with.
- 4.2** All equipment provided with the board for sailing purposes shall be in the board while afloat.
- 4.3** The penalty for not complying with one of the above instructions will be disqualification from all races sailed in which the instruction was broken.
- 4.4** Competitors shall report any damage or loss of equipment, however slight, to the organizing authority's representative immediately after securing the board ashore. The penalty for breaking this instruction, unless the protest committee is satisfied that the competitor made a determined effort to comply, will be disqualification from the race most recently sailed.
- 4.5** Class rules requiring competitors to be members of the class association will not apply.

APPENDIX M

RECOMMENDATIONS FOR PROTEST COMMITTEES

This appendix is advisory only; in some circumstances changing these procedures may be advisable. It is addressed primarily to protest committee chairmen but may also help judges, protest committee secretaries, race committees and others connected with protest and redress hearings.

In a protest or redress hearing, the protest committee should weigh all testimony with equal care; should recognize that honest testimony can vary, and even be in conflict, as a result of different observations and recollections; should resolve such differences as best it can; should recognize that no board or competitor is guilty until a breach of a *rule* has been established to the satisfaction of the protest committee; and should keep an open mind until all the evidence has been heard as to whether a board or competitor has broken a *rule*.

M1 PRELIMINARIES (may be performed by race office staff)

- Receive the *protest* or request for redress.
- Note on the form the time the *protest* or request is delivered and the protest time limit.
- Inform each *party*, and the race committee when necessary, when and where the hearing will be held.

M2 BEFORE THE HEARING

M2.1 Make sure that

- each *party* has a copy of or the opportunity to read the *protest* or request for redress and has had reasonable time to prepare for the hearing.
- only one person from each board (or *party*) is present unless an interpreter is needed.
- all boards and people involved are represented. If they are not, however, the committee may proceed under rule 63.3(b).
- boards' representatives were on board when required (rule 63.3(a)). When the *parties* were in different races, both organizing authorities must accept the composition of the protest committee (rule 63.8). In a *protest* concerning class rules, obtain the current

class rules and identify the authority responsible for interpreting them (rule 64.3(b)).

M2.2 Determine if any members of the protest committee saw the incident. If so, require each of them to state that fact in the presence of the *parties* (rule 63.6).

M2.3 Assess *conflicts of interest*.

- Ensure that all protest committee members declare any possible *conflicts of interest*. At major events this will often be a formal written declaration made before the event starts that will be kept with the protest committee records.
- At the start of any hearing, ensure that the *parties* are aware of any *conflicts of interest* of protest committee members. Ask the *parties* if they consent to the members. If a *party* does not object as soon as possible after a *conflict of interest* has been declared, the protest committee may take this as consent to proceed and should record it.
- If a *party* objects to a member, the remainder of the protest committee members need to assess whether the *conflict of interest* is significant. The assessment will consider the level of the event, the level of the conflict and the perception of fairness. It may be acceptable to balance conflicts between protest committee members. Guidance may be found on the World Sailing website. Record the decision and the grounds for that decision.
- In cases of doubt it may be preferable to proceed with a smaller protest committee. Except for hearings under rule 69, there is no minimum number of protest committee members required.
- When a request for redress is made under rule 62.1(a) and is based on an improper action or omission of a body other than the protest committee, a member of that body should not be a member of the protest committee.

M3 THE HEARING

M3.1 Check the validity of the *protest* or request for redress.

- Are the contents adequate (rule 61.2 or 62)?
 - Was it delivered in time? If not, is there good reason to extend the time limit (rule 61.3 or 62.2)?
 - When required, was the protestor involved in or a witness to the incident (rule 60.1(a))?
 - When necessary, was ‘Protest’ hailed and, if required, a red flag displayed correctly (rule 61.1(a))?

- When the flag or hail was not necessary, was the protestee informed?
- Decide whether the *protest* or request for redress is valid (rule 63.5).
- Once the validity of the *protest* or request has been determined, do not let the subject be introduced again unless truly new evidence is available.

M3.2 Take the evidence (rule 63.6).

- Ask the protestor and then the protestee to tell their stories. Then allow them to question one another. In a redress matter, ask the *party* to state the request.
- Invite questions from protest committee members.
- Make sure you know what facts each *party* is alleging before calling any witnesses. Their stories may be different.
- Allow anyone, including a board's crew, to give evidence. It is the *party* who normally decides which witnesses to call, although the protest committee may also call witnesses (rule 63.6). The question asked by a *party* 'Would you like to hear N?' is best answered by 'It is your choice.'
- Call each *party's* witnesses (and the protest committee's if any) one by one. Limit *parties* to questioning the witness(es) (they may wander into general statements).
- Invite the protestee to question the protestor's witness first (and vice versa). This prevents the protestor from leading his witness from the beginning.
- Allow members of the protest committee who saw the incident to give evidence (rule 63.6), but only while the *parties* are present. Members who give evidence may be questioned, should take care to relate all they know about the incident that could affect the decision, and may remain on the protest committee (rule 63.3(a)).
- Try to prevent leading questions or hearsay evidence, but if that is impossible discount the evidence so obtained.
- Accept written evidence from a witness who is not available to be questioned only if all *parties* agree. In doing so they forego their rights to question that witness (rule 63.6).
- Ask one member of the committee to note down evidence, particularly times, distances, speeds, etc.
- Invite first the protestor and then the protestee to make a final statement of her case, particularly on any application or interpretation of the *rules*.

M3.3 Find the facts (rule 63.6).

- Write down the facts; resolve doubts one way or the other.
- Call back *parties* for more questions if necessary.
- When appropriate, draw a diagram of the incident using the facts you have found.

M3.4 Decide the *protest* or request for redress (rule 64).

- Base the decision on the facts found (if you cannot, find some more facts).
- In redress cases, make sure that no further evidence is needed from boards that will be affected by the decision.

M3.5 Inform the *parties* (rule 65).

- Recall the *parties* and read them the facts found, conclusions and *rules* that apply, and the decision. When time presses it is permissible to read the decision and give the details later.
- Give any *party* a copy of the decision on request. File the *protest* or request for redress with the committee records.

M4 REOPENING A HEARING (rule 66)

M4.1 When a *party*, within the time limit, has asked for a hearing to be reopened, hear the *party* making the request, look at any video, etc., and decide whether there is any significant new evidence that might lead you to change your decision. Decide whether your interpretation of the *rules* may have been wrong; be open-minded as to whether you have made a mistake. If none of these applies refuse to reopen; otherwise schedule a hearing.

M4.2 Evidence is ‘new’

- if it was not reasonably possible for the *party* asking for the reopening to have discovered the evidence before the original hearing,
- if the protest committee is satisfied that before the original hearing the evidence was diligently but unsuccessfully sought by the *party* asking for the reopening, or
- if the protest committee learns from any source that the evidence was not available to the *parties* at the time of the original hearing.

M5 MISCONDUCT (rule 69)

M5.1 An action under this rule is not a *protest*, but the protest committee gives its allegations in writing to the competitor before the hearing. The hearing is conducted under rules similar to those governing a protest

hearing but the protest committee must have at least three members (rule 69.2(a)). Use the greatest care to protect the competitor's rights.

- M5.2** A competitor or a board cannot protest under rule 69, but the protest form of a competitor who tries to do so may be accepted as a report to the protest committee, which can then decide whether or not to call a hearing.
- M5.3** Unless World Sailing has appointed a person for the role, the protest committee may appoint a person to present the allegation. This person might be a race official, the person making the allegation or another appropriate person. When no reasonable alternative person is available, a person who was appointed as a member of the protest committee may present the allegation.
- M5.4** When it is desirable to call a hearing under rule 69 as a result of a Part 2 incident, it is important to hear any board-vs.-board *protest* in the normal way, deciding which board, if any, broke which *rule*, before proceeding against the competitor under rule 69.
- M5.5** Although action under rule 69 is taken against a competitor, board owner or *support person*, and not a board, a board may also be penalized (rules 69.2(h)(2) and 64.4).
- M5.6** When a protest committee upholds a rule 69 allegation it will need to consider if it is appropriate to report to either a national authority or World Sailing. Guidance on when to report may be found in the World Sailing Case Book. When the protest committee does make a report, it may recommend whether or not further action should be taken.
- M5.7** Unless the right of appeal is denied in accordance with rule 70.5, a *party* to a rule 69 hearing may appeal the decision of the protest committee.
- M5.8** Further guidance for protest committees about misconduct may be found on the World Sailing website.

M6 APPEALS (rule 70 and Appendix R)

When decisions can be appealed,

- retain the papers relevant to the hearing so that the information can easily be used for an appeal. Is there a diagram endorsed or prepared by the protest committee? Are the facts found sufficient? (Example: Was there an *overlap*? Yes or No. 'Perhaps' is not a fact found.) Are the names of the protest committee members and other important information on the form?

- comments by the protest committee on any appeal should enable the appeals committee to picture the whole incident clearly; the appeals committee knows nothing about the situation.

M7 PHOTOGRAPHIC EVIDENCE

Photographs and videos can sometimes provide useful evidence but protest committees should recognize their limitations and note the following points:

- The *party* producing the photographic evidence is responsible for arranging the viewing.
- View the video several times to extract all the information from it.
- The depth perception of any single-lens camera is very poor; with a telephoto lens, it is non-existent. When the camera views two *overlapped* boards at right angles to their course, it is impossible to assess the distance between them. When the camera views them head on, it is impossible to see whether an *overlap* exists unless it is substantial.
- Ask the following questions:
 - Where was the camera in relation to the boards?
 - Was the camera's platform moving? If so in what direction and how fast?
 - Is the angle changing as the boards approach the critical point? Fast panning causes radical change.
 - Did the camera have an unrestricted view throughout?

APPENDIX N

INTERNATIONAL JURIES

See rules 70.5 and 91(b). This appendix shall not be changed by the notice of race, sailing instructions or national prescriptions.

N1 COMPOSITION, APPOINTMENT AND ORGANIZATION

- N1.1** An international jury shall be composed of experienced sailors with excellent knowledge of the racing rules and extensive protest committee experience. It shall be independent of and have no members from the race committee, and be appointed by the organizing authority, subject to approval by the national authority if required (see rule 91(b)), or by World Sailing under rule 89.2(c).
- N1.2** The jury shall consist of a chairman, a vice chairman if desired, and other members for a total of at least five. A majority shall be International Judges.
- N1.3** No more than two members (three, in Groups M, N and Q) shall be from the same national authority.
- N1.4** (a) The chairman of a jury may appoint one or more panels composed in compliance with rules N1.1, N1.2 and N1.3. This can be done even if the full jury is not composed in compliance with these rules.
- (b) The chairman of a jury may appoint panels of at least three members each, of which the majority shall be International Judges. Members of each panel shall be from at least three different national authorities except in Groups M, N and Q, where they shall be from at least two different national authorities. If dissatisfied with a panel's decision, a *party* is entitled to a hearing by a panel composed in compliance with rules N1.1, N1.2 and N1.3, except concerning the facts found, if requested within the time limit specified in the sailing instructions.
- N1.5** When a full jury, or a panel, has fewer than five members, because of illness or emergency, and no qualified replacements are available, it remains properly constituted if it consists of at least three members and if at least two of them are International Judges. When there are three or four members they shall be from at least three different national authorities except in Groups M, N and Q, where they shall be from at least two different national authorities.

- N1.6** When it is considered desirable that some members not participate in discussing and deciding a *protest* or request for redress, and no qualified replacements are available, the jury or panel remains properly constituted if at least three members remain and at least two of them are International Judges.
- N1.7** In exception to rules N1.1 and N1.2, World Sailing may in limited circumstances (see World Sailing Regulation 25.8.13) authorize an international jury consisting of a total of only three members. All members shall be International Judges. The members shall be from three different national authorities (two, in Groups M, N and Q). The authorization shall be stated in a letter of approval to the organizing authority and in the notice of race and sailing instructions, and the letter shall be posted on the event's official notice board.
- N1.8** When the national authority's approval is required for the appointment of an international jury (see rule 91(b)), notice of its approval shall be included in the sailing instructions or be posted on the official notice board.
- N1.9** If the jury or a panel acts while not properly constituted, its decisions may be appealed.

N2 RESPONSIBILITIES

- N2.1** An international jury is responsible for hearing and deciding all *protests*, requests for redress and other matters arising under the rules of Part 5. When asked by the organizing authority or the race committee, it shall advise and assist them on any matter directly affecting the fairness of the competition.
- N2.2** Unless the organizing authority directs otherwise, the jury shall decide
- (a) questions of eligibility, measurement or rating certificates; and
 - (b) whether to authorize the substitution of competitors, boards or equipment when a *rule* requires such a decision.
- N2.3** The jury shall also decide matters referred to it by the organizing authority or the race committee.

N3 PROCEDURES

- N3.1** Decisions of the jury, or of a panel, shall be made by a simple majority vote of all members. When there is an equal division of votes cast, the chairman of the meeting may cast an additional vote.
- N3.2** Members shall not be regarded as having a significant *conflict of interest* (see rule 63.4) by reason of their nationality, club membership or

similar. When otherwise considering a significant *conflict of interest* as required by rule 63.4, considerable weight must be given to the fact that decisions of an international jury cannot be appealed and this may affect the perception of fairness and lower the level of conflict that is significant. In case of doubt, the hearing should proceed as permitted by rule N1.6.

N3.3 If a panel fails to agree on a decision it may adjourn, in which case the chairman shall refer the matter to a properly constituted panel with as many members as possible, which may be the full jury.

N4 MISCONDUCT (Rule 69)

N4.1 World Sailing Regulation 35, Disciplinary Code, contains procedures that apply to specific international events with regard to the appointment of a person to conduct any investigation. These procedures override any conflicting provision of this appendix.

N4.2 A person shall be responsible for presenting to the hearing panel any allegations of misconduct under rule 69. This person shall not be a member of the hearing panel but may be a member of the jury. Such a person shall be required to make full disclosure of all material that may come into his possession in the course of his investigation to the person subject to allegations of a breach of rule 69.

N4.3 Prior to a hearing, the hearing panel, to the extent practically possible, shall not act as an investigator of any allegations made under rule 69. However, during the hearing the panel shall be entitled to ask any investigative questions it may see fit.

N4.4 If the panel decides to call a hearing, all material disclosed to the panel in order for them to make that decision must be disclosed to the person subject to the allegations before the hearing begins.

APPENDIX R

PROCEDURES FOR APPEALS AND REQUESTS

See rule 70. A national authority may change this appendix by prescription but it shall not be changed by sailing instructions.

R1 APPEALS AND REQUESTS

Appeals, requests by protest committees for confirmation or correction of their decisions, and requests for interpretations of the *rules* shall be made in compliance with this appendix.

R2 SUBMISSION OF DOCUMENTS

R2.1 To make an appeal,

- (a) no later than 15 days after receiving the protest committee's written decision or its decision not to reopen a hearing, the appellant shall send an appeal and a copy of the protest committee's decision to the national authority. The appeal shall state why the appellant believes the protest committee's decision or its procedures were incorrect;
- (b) when the hearing required by rule 63.1 has not been held within 30 days after a *protest* or request for redress was delivered, the appellant shall, within a further 15 days, send an appeal with a copy of the *protest* or request and any relevant correspondence. The national authority shall extend the time if there is good reason to do so;
- (c) when the protest committee fails to comply with rule 65, the appellant shall, within a reasonable time after the hearing, send an appeal with a copy of the *protest* or request and any relevant correspondence.

If a copy of the *protest* or request is not available, the appellant shall instead send a statement of its substance.

R2.2 The appellant shall also send, with the appeal or as soon as possible thereafter, all of the following documents that are available to her:

- (a) the written *protest(s)* or request(s) for redress;
- (b) a diagram, prepared or endorsed by the protest committee, showing the positions and tracks of all boards involved, the course to the next *mark* and the required side, the force and direction of

the wind, and, if relevant, the depth of water and direction and speed of any current;

- (c) the notice of race, the sailing instructions, any other conditions governing the event, and any changes to them;
- (d) any additional relevant documents; and
- (e) the names, postal and email addresses, and telephone numbers of all *parties* to the hearing and the protest committee chairman.

R2.3 A request from a protest committee for confirmation or correction of its decision shall be sent no later than 15 days after the decision and shall include the decision and the documents listed in rule R2.2. A request for an interpretation of the *rules* shall include assumed facts.

R3 RESPONSIBILITIES OF NATIONAL AUTHORITY AND PROTEST COMMITTEE

Upon receipt of an appeal or a request for confirmation or correction, the national authority shall send to the *parties* and protest committee copies of the appeal or request and the protest committee's decision. It shall ask the protest committee for any relevant documents listed in rule R2.2 not sent by the appellant or the protest committee, and the protest committee shall promptly send them to the national authority. When the national authority has received them, it shall send copies to the *parties*.

R4 COMMENTS AND CLARIFICATIONS

R4.1 The *parties* and protest committee may make comments on the appeal or request or on any of the documents listed in rule R2.2 by sending them in writing to the national authority.

R4.2 The national authority may seek clarifications of *rules* governing the event from organizations that are not *parties* to the hearing.

R4.3 The national authority shall send copies of comments and clarifications received to the *parties* and protest committee as appropriate.

R4.4 Comments on any document shall be made no later than 15 days after receiving it from the national authority.

R5 INADEQUATE FACTS; REOPENING

The national authority shall accept the protest committee's finding of facts except when it decides they are inadequate. In that case, it shall require the committee to provide additional facts or other information, or to reopen the hearing and report any new finding of facts, and the committee shall promptly do so.

R6 WITHDRAWING AN APPEAL

An appellant may withdraw an appeal before it is decided by accepting the protest committee's decision.

APPENDIX S

STANDARD SAILING INSTRUCTIONS

This appendix applies only if the notice of race so states.

These Standard Sailing Instructions may be used at an event in place of printed sailing instructions made available to each board. To use them, state in the notice of race that ‘The sailing instructions will consist of the instructions in RRS Appendix S, Standard Sailing Instructions, and supplementary sailing instructions that will be on the official notice board located at _____.’

The supplementary sailing instructions will include:

- 1. A table showing the schedule of races, including the day and date of each scheduled day of racing, the number of races scheduled each day, the scheduled time of the first warning signal each day, and the latest time for a warning signal on the last scheduled day of racing (see SI 5 below).*
- 2. The location of the race office and of the flag pole on which signals made ashore will be displayed (SI 4.1).*
- 3. A list of the marks that will be used and a description of each one (SI 8). How new marks will differ from original marks (SI 10).*
- 4. The time limits, if any, that are listed in SI 12.*
- 5. Any changes or additions to the instructions in this appendix.*

A copy of the supplementary sailing instructions will be available to competitors on request.

SAILING INSTRUCTIONS

1 RULES

- 1.1 The regatta will be governed by the rules as defined in *The Windsurfing Competition Rules*.

2 NOTICES TO COMPETITORS

- 2.1 Notices to competitors will be posted on the official notice board.
- 2.2 Supplementary sailing instructions (called ‘the supplement’ below) will be posted on the official notice board.

3 CHANGES TO SAILING INSTRUCTIONS

- 3.1 Any change to the sailing instructions will be posted before 0800 on the day it will take effect, except that any change to the schedule of races will be posted by 2000 on the day before it will take effect.

4 SIGNALS MADE ASHORE

- 4.1 Signals made ashore will be displayed from the flag pole. The supplement will state its location.
- 4.2 When flag AP is displayed ashore, ‘1 minute’ is replaced with ‘not less than 60 minutes’ in the race signal AP.

5 SCHEDULE OF RACES

- 5.1 The supplement will include a table showing the days, dates, number of races scheduled, the scheduled times of the first warning signal each day, and the latest time for a warning signal on the last scheduled day of racing.

6 CLASS FLAGS

- 6.1 Each class flag will be the class insignia on a white background or as stated in the supplement.

7 THE COURSES

- 7.1 No later than the warning signal, the race committee will designate the course by displaying one or two letters followed by a number, and it may also display the approximate compass bearing of the first leg.
- 7.2 The course diagrams are on the pages following SI 13. They show the courses, the order in which marks are to be passed, and the side on which each mark is to be left. The supplement may include additional courses.

8 MARKS

- 8.1** A list of the marks that will be used, including a description of each one, will be included in the supplement.

9 THE START

- 9.1** Races will be started by using RRS 26.
- 9.2** The starting line will be between a staff displaying an orange flag on the race committee vessel and the course side of the starting mark.

10 CHANGE OF THE NEXT LEG OF THE COURSE

- 10.1** To change the next leg of the course, the race committee will lay a new mark (or move the finishing line) and remove the original mark as soon as practicable. When in a subsequent change a new mark is replaced, it will be replaced by an original mark.

11 THE FINISH

- 11.1** The finishing line will be between a staff displaying an orange flag on the race committee vessel and the course side of the finishing mark.

12 TIME LIMITS

- 12.1** The supplement will state which of the following time limits, if any, will apply and, for each, the time limit.
- **Mark 1 Time Limit** Time limit for the first board to pass Mark 1.
 - **Race Time Limit** Time limit for the first board to sail the course and finish.
 - **Finishing Window** Time limit for boards to finish after the first board sails the course and finishes.
- 12.2** If no board has passed Mark 1 within the Mark 1 Time Limit, the race shall be abandoned.
- 12.3** Boards failing to finish within the Finishing Window shall be scored Did Not Finish without a hearing. This changes RRS 35, A4 and A5.

13 PROTESTS AND REQUESTS FOR REDRESS

- 13.1** Protest forms are available at the race office. Protests and requests for redress or reopening shall be delivered there within the appropriate time limit.
- 13.2** For each class, the protest time limit is 60 minutes after the last board has finished the last race of the day or the race committee signals no more racing today, whichever is later.

- 13.3** Notices will be posted no later than 30 minutes after the protest time limit to inform competitors of hearings in which they are parties or named as witnesses and where the hearings will be held.
- 13.4** Notices of protests by the race committee, technical committee or protest committee will be posted to inform boards under RRS 61.1(b).
- 13.5** On the last scheduled day of racing a request for redress based on a protest committee decision shall be delivered no later than 30 minutes after the decision was posted. This changes RRS 62.2.

COURSE DIAGRAMS

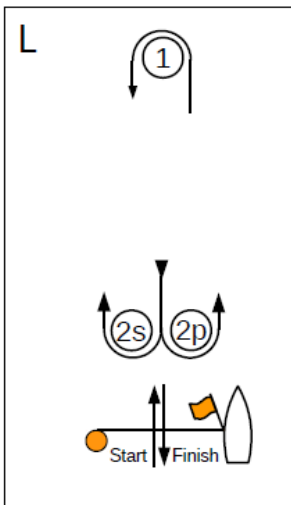

Course L Windward/Leeward, Leeward Finish	
<i>Signal</i>	<i>Mark Rounding Order</i>
L2	Start – 1 – 2s/2p – 1 – Finish
L3	Start – 1 – 2s/2p – 1 – 2s/2p – 1 – Finish
L4	Start – 1 – 2s/2p – 1 – 2s/2p – 1 – 2s/2p – 1 – Finish

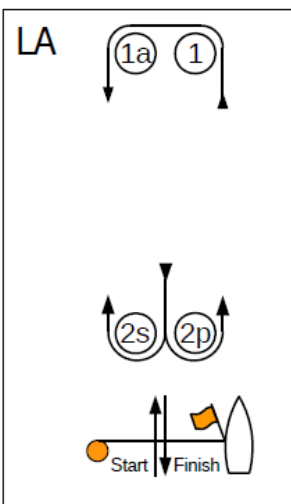

Course LA Windward/Leeward with Offset Mark Leeward Finish	
<i>Signal</i>	<i>Mark Rounding Order</i>
LA2	Start – 1 – 1a – 2s/2p – 1 – 1a – Finish
LA3	Start – 1 – 1a – 2s/2p – 1 – 1a – 2s/2p – 1 – 1a – Finish
LA4	Start – 1 – 1a – 2s/2p – 1 – 1a – 2s/2p – 1 – 1a – 2s/2p – 1 – 1a – Finish

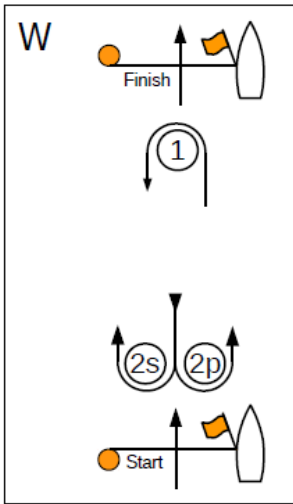

Course W Windward/Leeward Windward Finish	
<i>Signal</i>	<i>Mark Rounding Order</i>
W2	Start – 1 – 2s/2p – Finish
W3	Start – 1 – 2s/2p – 1 – 2s/2p – Finish
W4	Start – 1 – 2s/2p – 1 – 2s/2p – 1 – 2s/2p – Finish

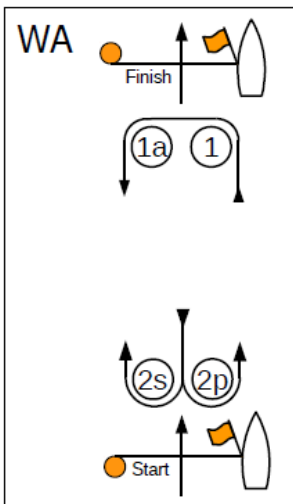

Course WA Windward/Leeward with Offset Mark, Windward Finish	
<i>Signal</i>	<i>Mark Rounding Order</i>
WA2	Start – 1 – 1a – 2s/2p – Finish
WA3	Start – 1 – 1a – 2s/2p – 1 – 1a – 2s/2p – Finish
WA4	Start – 1 – 1a – 2s/2p – 1 – 1a – 2s/2p – 1 – 1a – 2s/2p – Finish

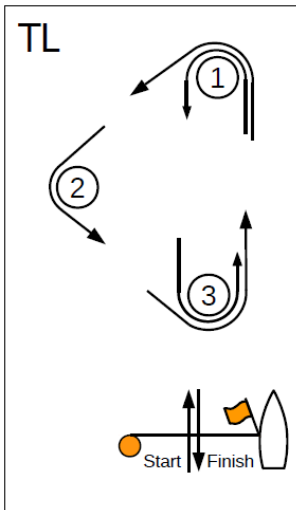

Course TL Triangle Leeward Finish	
<i>Signal</i>	<i>Mark Rounding Order</i>
TL2	Start – 1 – 2 – 3 – 1 – Finish
TL3	Start – 1 – 2 – 3 – 1 – 3 – 1 – Finish
TL4	Start – 1 – 2 – 3 – 1 – 3 – 1 – 3 – 1 – – Finish

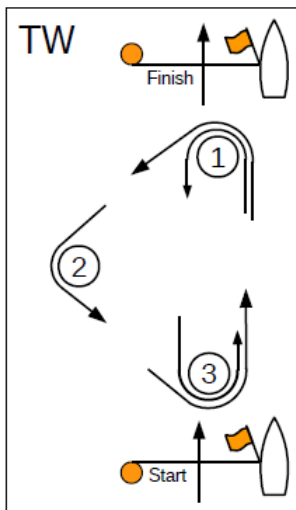

Course TW Triangle Windward Finish	
<i>Signal</i>	<i>Mark Rounding Order</i>
TW2	Start – 1 – 2 – 3 – Finish
TW3	Start – 1 – 2 – 3 – 1 – 3 – Finish
TW4	Start – 1 – 2 – 3 – 1 – 3 – 1 – 3 – Finish

APPENDIX T

ARBITRATION

This appendix applies only if the notice of race or sailing instructions so state.

Arbitration adds an extra step to the protest resolution process but can eliminate the need for some protest hearings, thus speeding up the process for events in which many protests are expected. Arbitration may not be appropriate for all events as it requires an additional knowledgeable person to act as the arbitrator. Further guidance on arbitration can be found in the World Sailing International Judges Manual, which can be downloaded from the World Sailing website.

T1 POST-RACE PENALTIES

- (a) Provided that rule 44.1(b) does not apply, a board that may have broken one or more rules of Part 2 or rule 31 in an incident may take a Post-Race Penalty at any time after the race until the beginning of a protest hearing involving the incident.
- (b) A Post-Race Penalty is a 20% Scoring Penalty calculated as stated in rule 44.3(c). However, rule 44.1(a) applies.
- (c) A board takes a Post-Race Penalty by delivering to the arbitrator or a member of the protest committee a written statement that she accepts the penalty and that identifies the race number and where and when the incident occurred.

T2 ARBITRATION MEETING

An arbitration meeting will be held prior to a protest hearing for each incident resulting in a *protest* by a board involving one or more rules of Part 2 or rule 31, but only if each *party* is represented by a person who was on board at the time of the incident. No witnesses will be permitted unless the arbitrator decides that he needs them. However, if the arbitrator decides that rule 44.1(b) may apply or that arbitration is not appropriate, the meeting will not be held, and if a meeting is in progress, it will be closed.

T3 ARBITRATOR'S OPINION

Based on the evidence given by the representatives, the arbitrator will offer an opinion as to what the protest committee is likely to decide:

- (a) the *protest* is invalid,

- (b) no board will be penalized for breaking a rule, or
- (c) one or more boards will be penalized for breaking a rule, identifying the boards and the penalties.

T4 ARBITRATION MEETING OUTCOMES

After the arbitrator offers an opinion,

- (a) a board may take a Post-Race Penalty, and
- (b) a board may ask to withdraw her *protest*. The arbitrator may then act on behalf of the protest committee in accordance with rule 63.1 to allow the withdrawal.

Unless all *protests* involving the incident are withdrawn, a protest hearing will be held.

ADDENDUM SL

EXPERIMENTAL SLALOM RULES

The Windsurfing Slalom Competition Rules for 2017-2020 (WSR) has been created as a convenient book for use at windsurfing slalom competition events. In slalom competitions boards will compete in elimination and only a limited number of them may advance from round to round.

Heat	Elimination race
Round	Several heats on the same level
Elimination	One or more rounds

S1.1 Add or change the next definitions:

Capsized A board is *capsized* when
 (a) she is not under control and slows down significantly because her sail is in the water or the competitor is separated from the board,
 (b) The competitor is water starting.

Finish A board *finishes* when any part of her hull, or crew or equipment in normal position, crosses the finishing line from the course side.

Inside/ outside board *Inside* board is the board which course at that moment is the closest to a *mark* or *obstruction*. The other board is the *outside* board.

Overtaking A board is *overtaking* from the moment she gains an *overlap* from *clear astern* until the moment the *overlap* is *broken*.

Rounding or Passing A board is *rounding* or *passing* a mark or an obstruction from the time when her proper course is to begin to manoeuvre to round or pass it, until the mark or obstruction has been rounded or passed.

Room The space a board needs in the existing conditions to sail her proper course to a mark or an obstruction and space to manoeuvre when rounding or passing this mark or obstruction including space to change the tack, if it is a part of the manoeuvre.

***Serious
damage***

A damage which worsens the performance of a board.

S1.2 Add or change the following rules in Part 1:

2 FAIR SAILING

A competitor shall compete in compliance with recognized principles of sportsmanship and fair play. A competitor may be penalized under this rule only if it is clearly established that these principles have been violated or he/she was sailing in manner that can be considered as dangerous or reckless. The penalty shall be either disqualification or disqualification that is not excludable.

4 DECISION TO RACE

The responsibility for a competitor's decision to participate in a race or to continue *racing* is his/hers alone.

8 LAST POINT OF CERTAINTY

When there is a doubt as to relationship or change of relationship between boards, the last point of certainty will apply

S1.3 Add or change the following rules in Part 2:

Preamble to Part 2

*The rules of Part 2 apply between boards that are sailing in or near the **racing** area and intend to **race**, are **racing**, or have been **racing**. However, a board not **racing** shall not be penalized for breaking one of these rules, except rule 14 when the incident resulted in injury or serious damage or rule 24.1. When rules 23 or 24 apply, the other rules in Part 2 do not.*

Delete the preambles of Sections A, C and D.

11 OVERTAKING

The *overtaking* board shall *keep clear* and the *overtaken* board shall not change course if as a result the other board would need to take action to avoid contact. The *inside* board is entitled to *room*.

13 CHANGING TACK

A board *changing tack* shall keep clear of a board which is not. If two boards are subject to this rule at the same time, the one of the other's port side or the one *clear astern* shall *keep clear*.

14 AVOIDING CONTACT

A board shall avoid contact with another board if reasonably possible but no board shall be penalized under this rule unless there is contact that causes injury or *serious damage*.

15 Deleted

16 CHANGING COURSE

When a right-of-way board changes course or slows down, she shall give the other board *room* to *keep clear*.

17 Deleted

18 Rules 18.1,18.2(a),(b),(c)(e), 18.3 and 18.4 are deleted and replaced by:

ROUNDING/PASSING MARK OR OBSTRUCTION

An *inside overlapped* board or a *clear ahead* board is entitled to *room* when *rounding/ passing a mark* or *obstruction*.

When an *inside overlapped* board must change a tack or bear away at the mark to sail her *proper course*, until she changes the tack or bear away she shall sail not farther from the *mark* than needed to sail that course.

21 EXONERATION

When a board is sailing within the *room* to which she is entitled, she shall be exonerated if, in an incident with a board required to give her *room*, she breaks a rule of Part 2.

24.1 A board not racing shall not interfere with a board that is racing and shall not sail in the course area defined in the sailing instructions when races are taking place except when the race is her own. A board that breaks this rule shall be penalized without a hearing from the race committee and her penalty shall apply to the race sailed nearest to the time of the incident.

24.3 During the last 30 seconds before her starting signal, a board that stops, slows down significantly, or one that is not making significant forward progress shall *keep clear* of all others unless she is accidentally *capsized*.

ADDENDUM SL1 - ELIMINATION LADDERS

SLALOM LADDER A

ELIMINATION SCHEDULE

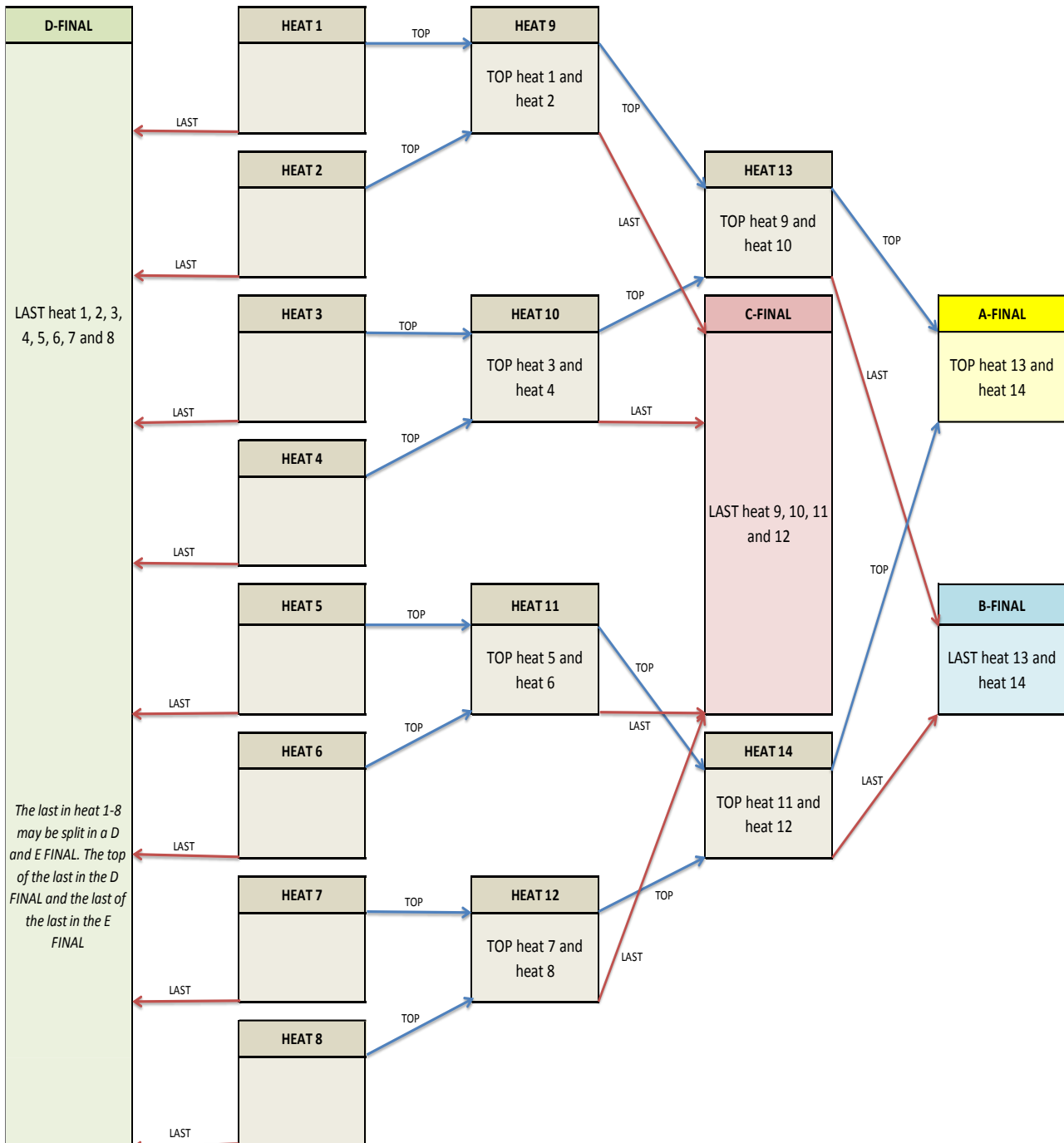

SLALOM LADDER B



ELIMINATION SCHEDULE

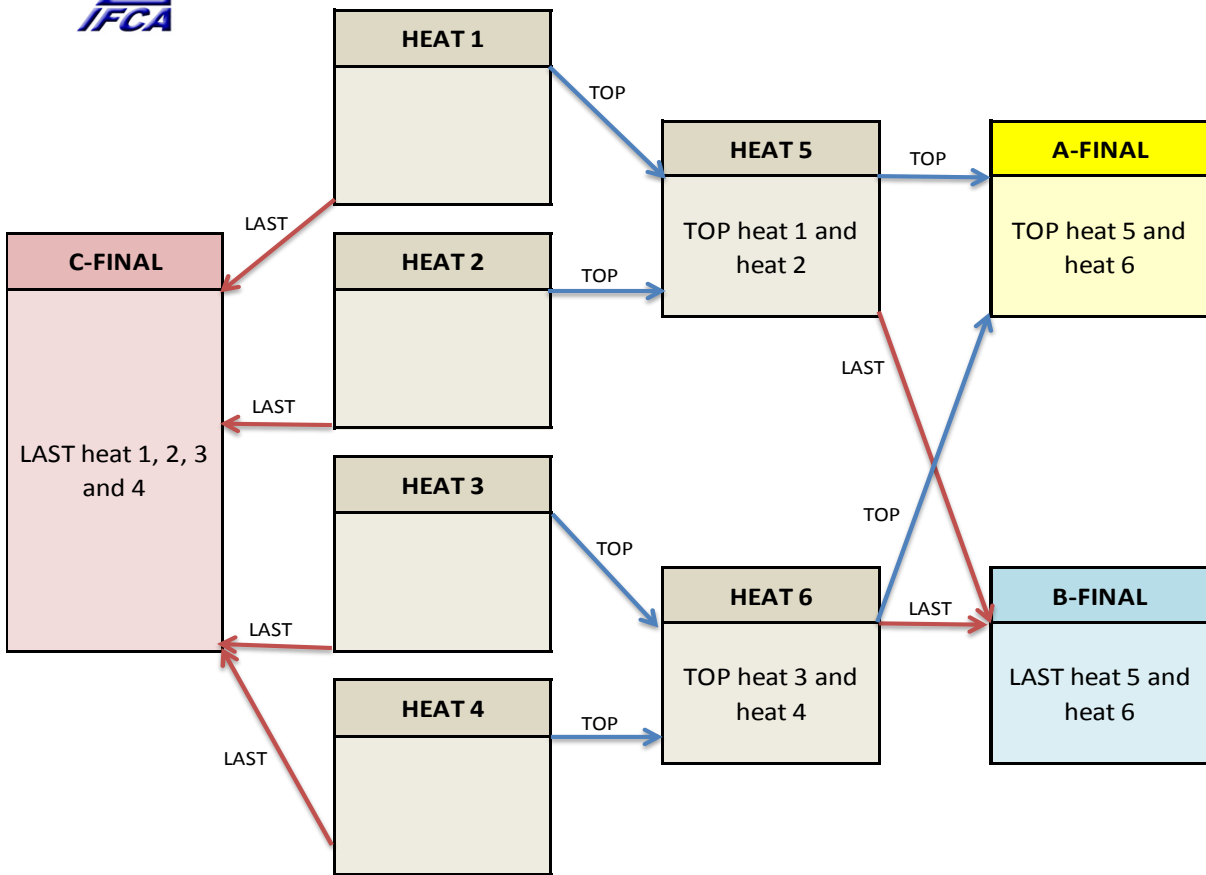

SLALOM LADDER C



ELIMINATION SCHEDULE

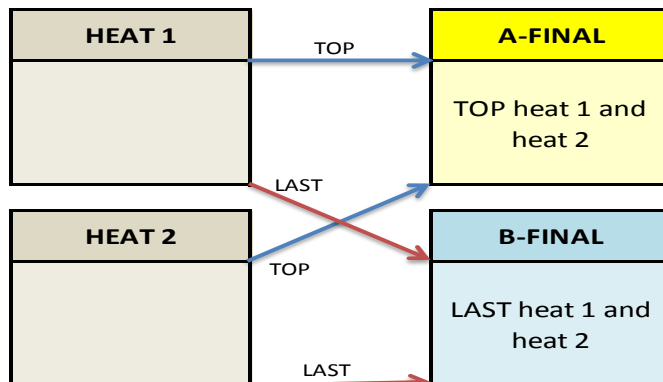

ADDENDUM SL2 – ELIMINATION SCHEDULE

Slalom Distribution Table														
Maximum 80 Competitors				Maximum 40 Competitors				Maximum 20 Competitors						
Heat No	Competitor No			Heat No	Competitor No			Heat No	Competitor No					
1	6	38	70	1	3	19	35	1						
	11	43	75		6	22	38							
	22	54			11	27								
	27	59			14	30								
2	3	35	67	2	2	18	34					2	10	18
	14	46	78		7	23	39					3	11	19
	19	51			10	26						6	14	
	30	62			15	31						7	15	
3	7	39	71	3	4	20	36	2						
	10	42	74		5	21	37							
	23	55			12	28						1	9	17
	26	58			13	29						4	12	20
4	2	34	66	4	1	17	33					5	13	
	15	47	79		8	24	40					8	16	
	18	50			9	25								
	31	63			16	32								
5	5	37	69	4	1	17	33	2						
	12	44	76		8	24	40							
	21	53			9	25								
	28	60			16	32								
6	4	36	68	4	1	17	33					5	13	
	13	45	77		8	24	40					8	16	
	20	52			9	25								
	29	61			16	32								
7	8	40	72	4	1	17	33	2						
	9	41	73		8	24	40							
	24	56			9	25								
	25	57			16	32								
8	1	33	65	4	1	17	33					5	13	
	16	48	80		8	24	40					8	16	
	17	49			9	25								
	32	64			16	32								

ADDENDUM SL3 – COURSES

FIGURE OF EIGHT SLALOM

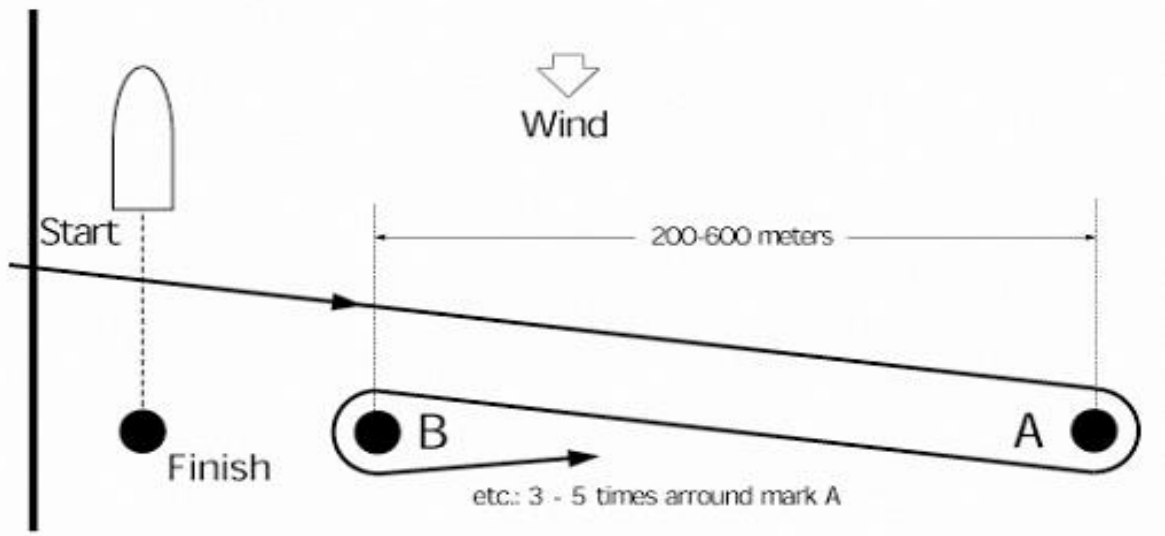

Note: The start can be from the beach or on the water near the marks A or B. If the wind is not cross shore starts should normally be on the water. The finish can be to windward or leeward of mark B, on the water or the beach.

DOWNWIND SLALOM

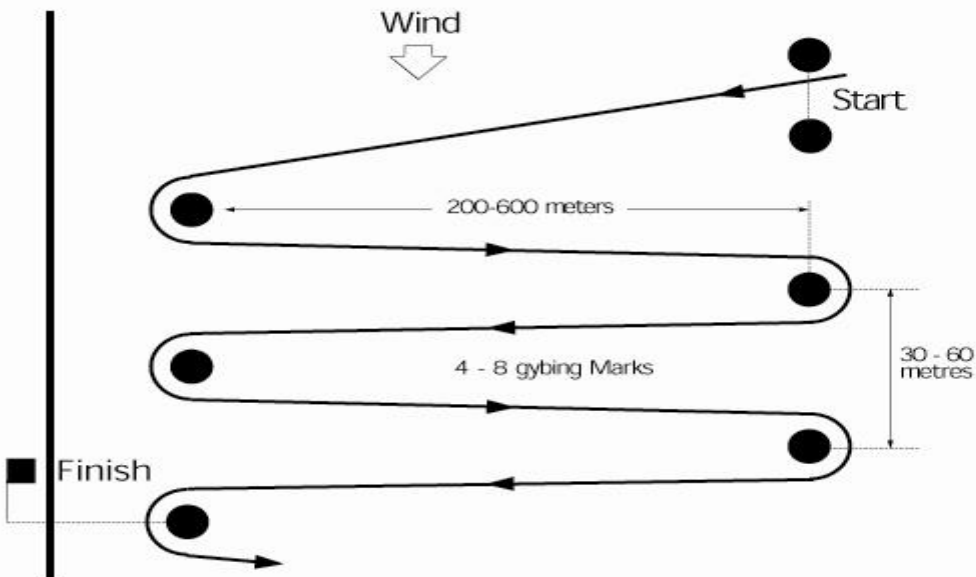

PROTEST FORM – also for requests for redress and reopening

Fill in and tick as appropriate

1. **EVENT** Organizing authority Date Race no.

2. TYPE OF HEARING

- | | | | |
|--|--------------------------|--|--------------------------|
| Protest by board against board | <input type="checkbox"/> | Request for redress by board or race committee | <input type="checkbox"/> |
| Protest by race committee against board | <input type="checkbox"/> | Consideration of redress by protest committee | <input type="checkbox"/> |
| Protest by protest committee against board | <input type="checkbox"/> | Request by board or race committee to reopen hearing | <input type="checkbox"/> |
| | | Consideration of reopening by protest committee | <input type="checkbox"/> |

3. BOARD PROTESTING, OR REQUESTING REDRESS OR REOPENING

Class Fleet Sail no. Board's name
 Represented by Phone Email

4. BOARD(S) PROTESTED OR BEING CONSIDERED FOR REDRESS

Class Fleet Sail no. Board's name

5. INCIDENT

Where and when the incident occurred
 Rules alleged to have been broken Witnesses

6. INFORMING PROTESTEE How did you inform the protestee of your intention to protest?

- By hailing When? Word(s) used
- By displaying a red flag When?
- By informing her in some other way Give details

7. DESCRIPTION OF INCIDENT (use another sheet if necessary)

Diagram: one square = hull length; show positions of boards, wind and current directions, marks.

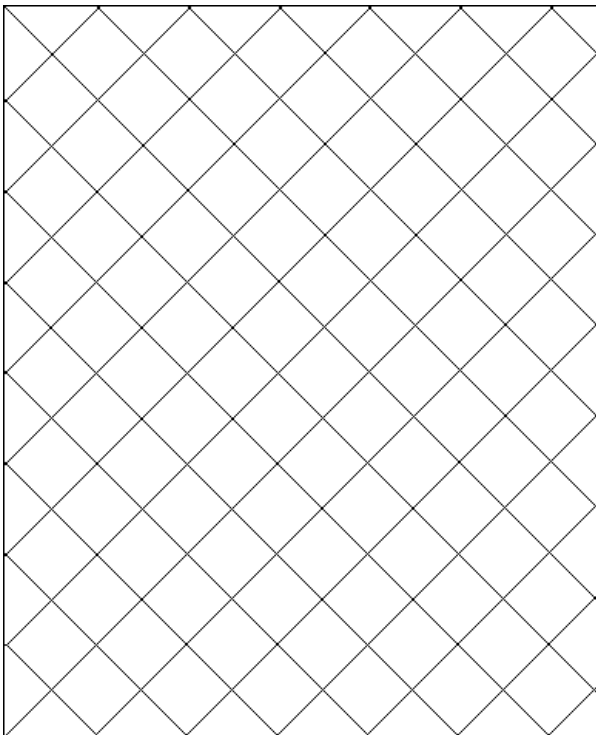

.....

THIS SIDE FOR PROTEST COMMITTEE USE

Number

Fill in and tick as appropriate

Heard together with numbers

Withdrawal requested Signature Withdrawal permitted

Class Fleet Race

Protest, or request for redress or reopening, received within time limit Time limit extended

Protestor, or party requesting redress or reopening, represented by

Other party, or board being considered for redress, represented by

Names of witnesses

Interpreters

Remarks

Conflict of interest declared Objections: Yes No

Written protest or request identifies incident

'Protest' hailed at first reasonable opportunity

No hail needed; protestee informed at first reasonable opportunity

Red flag conspicuously displayed at first reasonable opportunity

Protest or request valid; hearing will continue Protest or request invalid; hearing is closed

FACTS FOUND ¹³¹

Diagram of board is endorsed by committee Committee's diagram is attached

CONCLUSIONS AND RULES THAT APPLY

.....
.....
.....
.....
.....
.....
.....
.....
.....
.....
.....
.....
.....

DECISION

Protest: dismissed Board(s) is (are) disqualified from race(s)
penalized as follows :

Redress: not given given as follows :

Request to reopen a hearing: denied granted

Protest committee chairman and other members

.....

Chairman's signature Date and time

